Title

Field of Application for:
Flamebreak 660 Ply Faced and
FF660 MDF Faced Doorset
Ranges in Timber Based Door
Frames

For 60 minutes Fire Resistance

Report No.:

FEA/F02141 Revision M

Issue Date:

30th April 2024

Valid Until:

9th February 2028

Job Reference:

WF534966

Prepared for:

Pacific Rim Wood Ltd.

Ground Floor Suite
Block B, Old Kelways,
Somerton Road,
Langport,
Somerset
TA10 9SJ

Contents	Page No.
Contents	2
1 Foreword	4
2 Proposal	5
2.1 Assumptions	5
3 Test Data.....	5
3.1 Test Evidence	6
4 Technical Specification.....	9
4.1 General	9
4.2 Intended Use.....	9
4.3 Door Leaf	10
4.4 Door Frames	10
4.5 Doorset Configurations & Maximum Leaf Sizes.....	11
5 General Description of Leaf Construction	39
5.1 Leaf Core Construction	39
5.2 Leaf Size Adjustment During Manufacturing.....	41
5.3 Timber Lipping – Flamebreak 660 Ply Faced and FF660 MDF Faced.....	42
5.4 Edge Protectors	44
5.5 Decorative & Protective Facings – Flamebreak 660 Ply Faced and FF660 MDF Faced	46
5.6 Decorative Planted on Timber Mouldings – both Leaf Options	47
6 Glazing within the Leaf	48
6.1 General	48
6.2 Glazing Beads & Installation – all Leaf Options	51
6.3 Pyroclear 60-001 (6mm thick) – Pilkington Group Ltd.....	57
6.4 Pyrostop 60-101 (23mm thick) – Pilkington Group Ltd.....	57
6.5 Pyroguard 60-23 (23mm thick) – Pyroguard UK Ltd	58
6.6 Pyrobel 25 (25mm thick) – AGC Flat Glass Europe.....	58
6.7 Norsound – Norsound Vision 60B & 60T	59
6.8 Norsound Ltd – Norsound Vision 60 Slimline	61
6.9 Norsound Ltd. – Norsound Universal 60B & 60T	62
6.10 Sealed Tight solutions Ltd - ST105GT and ST105GT(3)	64
6.11 Glazing Pins for Glazing Within Leaf	67
7 Door Frame Construction	68
7.1 Frame Section Details	68
7.2 Threshold	69
7.3 Door Frame Joints.....	70

8	Overpanels, Fanlights & Sidelights	71
8.1	Solid overpanels within Door Frame on all edges (transomed).....	71
8.2	Glazed Screens, Glazed Fanlights & Sidescreens	73
8.3	General	73
8.4	Norsound Vision Glazing Systems – Fanlights & Side Screens.....	76
9	Adhesives.....	81
10	Hardware.....	82
10.1	General	82
10.2	Intumescent to Hardware	83
10.3	Essential Hardware	84
10.4	Latches & Locks.....	85
10.5	Handles.....	88
10.6	Butt Hinges	89
10.7	Doorset Self Closing	90
10.8	Flush Bolts	91
10.9	Non-Essential Hardware	92
11	Installation	98
11.1	General	98
11.2	Door Frame Installation	98
11.3	Firestopping	99
11.4	Packers.....	100
11.5	Wall Types, Structural Opening & Fixity	101
11.6	Postproduction (Onsite) Leaf Size Adjustment	103
11.7	Door Gaps.....	103
12	Insulation Performance.....	103
13	Conclusion	103
14	Declaration by the Applicant	104
15	Limitations	105
16	Validity.....	106
	Appendix A Summary of Supporting Test Evidence	107
	Appendix B Revisions.....	109
	Appendix C Test Report Summaries.....	111

1 Foreword

This Field of Application report has been commissioned by Pacific Rim Wood Ltd and relates to the fire resistance of 60-minute fire resisting doorset designs that comprise either Flamebreak 660 Ply faced and FF660 MDF faced door blanks. Door blank constructions are manufactured by P.T. Kutai Timber of Indonesia.

The Field of Application (scope) is for National Application and has been written in accordance with the general principles outlined in BS EN 15725: 2010; *Extended application reports on the fire performance of construction products and building elements*.

This Field of Application (scope) uses established empirical methods of extrapolation and experience of fire testing similar doorsets, in order to extend the scope of application by determining the limits for the designs based on the tested constructions and performances obtained. The scope is an evaluation of the potential fire resistance performance if the variations specified herein were to be tested in accordance with BS 476 Part 22:1987.

This Field of Application has been written using appropriate test evidence generated at UKAS accredited laboratories, to the relevant test standard. The supporting test evidence has been deemed appropriate to support the manufacturers stated door design and is summarised in section 3 and appendices A & C.

The scope presented in this report relates to the behaviour of the proposed door design variations under the particular conditions of the test; they are not intended to be the sole criterion for considering the potential fire hazard of the door assembly in use.

This Field of Application has been prepared and checked by product assessors with the necessary competence, who subscribe to the principles outlined in the Passive Fire Protection Forum (PFPF) 'Guide to Undertaking Technical Assessments of the Fire Performance of Construction Products Based on Fire Test Evidence'. The aim of the PFPF guidelines is to give confidence to end-users that assessments that exist in the UK are of a satisfactory standard to be used for building control and other purposes.

Valid Certifire and/or field of application supporting documentation has been used to increase the scope of application of this report. It is the responsibility of users to check that the cited versions of such supporting documentation remain valid at the time of use. Where new revisions or revalidations of supporting documentation have been issued, they must be checked against those referenced in this report and, if their scope has changed, Warringtonfire must be consulted to review and consider the effect of these changes on the scope and conclusions of this report.

The drawings provided in this report are for guidance and illustrative purposes only. Please note that the written scope of application takes precedence.

2 Proposal

It is proposed to consider the fire resistance performance of the specified proprietary Flamebreak 660 Ply faced and FF660 MDF faced door blank designs, for 60 minutes fire resistance integrity performance (and where appropriate insulation performance), if the doorset designs were to be tested to the requirements of BS 476 Part 22:1987, *Methods for determination of the fire resistance of non-loadbearing elements of construction*.

The field of application defined in this report is based on the fire resistance test evidence for the doorset design, which is summarised in section 3 and appendices A & C. Analysis of specific construction details that require assessment are given within this report against the relevant element of construction, as appropriate.

This Field of Application (FoA) provides additional information when fitting specific components to doorsets that may be required to meet other performance objectives than fire resistance. This information is included to assist the end user when considering fire resistance alongside other performance requirements, such as smoke leakage performance. It is important to note, however, this report does not directly consider any performance other than fire resistance. Any other performance requirement for the door designs considered herein is to be subject to a separate analysis.

2.1 Assumptions

- All densities referred to in this document are based upon an assumed moisture content of 10 - 12%
- It is assumed that unless otherwise documented in the field of application sections of this report, the doorset subject to this report will be constructed in accordance with the test evidence referred to herein.
- For components created using solid timber sections referred to in this assessment, it is assumed that, for all timbers, they will be of a quality deemed to meet or exceed class J30 as specified in BS EN 942: 2007, subject to adequate repairs, other than glazing beads which must meet a minimum class J10. Note that areas under intumescent seals/gaskets are not considered to be concealed faces and defects must be repaired.
- Where timber is referred to within this document it is assumed that the timber element is made from a continuous solid piece, unless specifically detailed otherwise.
- All dimensions detailed herein may be varied by $\pm 2\%$ except where minimum, maximum or a range of dimensions are given.

3 Test Data

The test evidence summarised below and in appendices A & C has been generated to support the fire resistance performance of the door designs that are the subject of this field of application. The summary details are considered to be the key aspects of the design tested.

Note:

- Dimensions are in mm unless otherwise stated.
- Abbreviations: (h) = height; (w) = width; (t) = thickness; (d) = deep; (l) = long.
- Latches fitted but disengaged for the test, are reported as 'unlatched'.

The test evidence has been generated across a number of different doorset configurations, including single leaf, double leaf, latched and unlatched doorsets as well as doorsets with sidescreens and overpanels.

Some of the test evidence used in the evaluation is over 5 years old. In accordance with industry guidance, the evidence has been reviewed to consider its suitability. Warringtonfire are satisfied that there have been no significant revisions to the relevant test standards which would render the evidence irrelevant.

The evidence has been generated to BS 476 Part 22:1987 and EN 1634-1. The latter is known to be more onerous than the BS 476 Part 22:1987 standard, primarily due to the use of plate thermocouples within the furnace to record the furnace temperature.

The same time temperature curve is used to control the temperature within the furnace for both test methods (the heating curve given within ISO 834-1). However, the plate thermocouple used to record the temperature within the furnace for the EN test method, requires a longer thermal exposure to read the same temperature as the probe thermocouple that is used for the BS 476: Part 22: 1987 test, particularly during the early stages of the test. Furthermore, the neutral pressure regime is positioned lower relative to the specimen height in a European fire door test, therefore resulting in greater relative positive pressure conditions than those expected in a BS 476-22: 1987 test, which has the potential to increase hot gases and flaming on the unexposed side. These factors result in more onerous test conditions for doorsets tested to the BS EN 1634-1 test standard compared with the BS 476: Part 22: 1987 test standard, which has been demonstrated by testing the same products to both standards.

It is therefore the opinion of Warringtonfire that the evidence cited in the following section, tested to both named standards referenced above can be utilised in this assessment which will conclude in terms of the fire resistance performance of the Flamebreak 660 Ply faced and FF660 MDF faced door blank designs if tested in accordance with BS 476 Part 22:1987.

Refer to test summaries in appendix C for discussion of failure modes, if applicable.

3.1 Test Evidence

Primary Test Data				
Report Reference	Configuration	Leaf Size (mm)	Performance (mins)	
RF02054	A: ULSASD	2070 935 54	Integrity:	54
	B: ULSASD	2062 935 54	Integrity:	58
RF02054 is presented as primary data for the Flamebreak 660 Ply faced single leaf design when utilising Palusol intumescent seals				
RF02055	ULSADD	2155 935/845 54	Integrity:	60
RF02055 is presented as primary data for the Flamebreak 660 Ply faced single and double leaf designs when utilising Pyrostrip 500P intumescent seals				

RF02117	A: ULSASD	2080 937 54	Integrity:	71
	B: ULSASD	2380 1179 54	Integrity:	61
RF02177 is presented as primary data for the Flamebreak 660 Ply faced in large single leaf designs when utilising Pyrostrip 500P intumescent seals				
RF05042	A: ULSASD	2080 936 54	Integrity:	63
RF05042 is presented as primary data for the Flamebreak FF660 MDF faced single leaf design when utilising Pyrostrip 500P intumescent seals				
RF08117 Revision A	B: ULSASD	2040 826 54	Integrity:	62
RF08117 is presented as primary data for the Flamebreak FF660 MDF faced single leaf designs when utilising Pyroplex Ltd Rigid Box Seals intumescent seals				
WF307381 Issue 2	ULSADD	2156 936/936 54	Integrity:	62
WF307381 is presented as primary data for the Flamebreak 660 Ply faced single and double leaf designs when utilising Pyroplex intumescent seals				
WF374929	A: ULSASD	2200 926 54	Integrity:	60
			Insulation:	60
WF374929 is presented as primary data for the Flamebreak 660 Ply faced single leaf design supporting trimming options in section 5.2.1 and locksets in section 10.4.1				
WF503863	A: LSASD	2055 936 54	Integrity:	65
			Insulation:	63
WF503863 is presented as primary data for the Flamebreak FF660 MDF faced single leaf design when utilising Pyrostrip 500P intumescent seals. This test specimen was sampled by BMTRADA during manufacture				
WF408272 AR1	LSASD	2040 928 54	Integrity:	71
			Insulation:	71
WF408272 is presented as primary data for the Flamebreak 660 Ply faced single leaf design when utilising STS ST154 intumescent seals and a multipoint lockset				
RF05036	ULSASD	2133 1037 54	Integrity:	64
RF05036 comprised a glazed single leaf doorset mounted in a glazed screen, and is presented as supporting test data for the use of glazed fanlights and sidescreens				
WF532372	2No. ULSASD	Both specimens:	Integrity:	A: 76 B: 76

		2041 1028 54	Insulation:	A: 65 B: 65
--	--	--------------------	-------------	----------------

WF532372 is presented as primary data for the Flamebreak FF660 MDF faced single leaf design when utilising Lorient Type 617 and Pyroplex Rigid Box Seals intumescent seals. This test specimen was sampled by BMTRADA during manufacture. WF532372 is also presented as supporting data for the use of T-shaped lippings as detailed in section 5.3

Supplementary Test Data

The following test evidence has been incorporated to support the use of the Norsound Ltd. glazing system assessed in sections 6.7, 6.8 and 8.4.

The performance column indicates the result obtained by the screen and doorset.

Report Reference	Pane Size & Glazing System (mm)		Performance (mins)
IF12006	1090 x 1090 fixed leaf with 891(h) x 886(w) aperture using Norsound Vision 60 Slimline and Liner and Pilkington Pyroshield 2 glass		64
IF12027	1052 x 1020 fixed leaf with 814(h) x 814(w) aperture using Norsound Vision 60 and Liner and Pilkington Pyroshield 2 glass		68
IF12051	1300 x 1300 glazed screen with 814(h) x 814(w) aperture using Norsound Norglaze 60 and Liner and Pilkington Pyrodur EW60-10 glass		79
IF12053	1300 x 1300 glazed screen with 4No apertures: 484(h) x 383(w); 484(h) x 821(w); 720(h) x 383(w); 720(h) x 821(w) each glazed using Norsound Vision 60 and Liner and Pilkington Pyrodur EW60-10 glass		75
IF13077	1022 x 1054 swinging leaf with 752(h) x 720(w) aperture glazed using Norsound Universal and Liner and Schott Pyran-S glass		64
CF127	Dorma UK Ltd Certifire Approval against TS34 for the use of floor springs and top pivots		-
RF11061	2No. ULSASD	Each Leaf: 980	Integrity: A: 66 B: 68
		900 54	Insulation: A: 66 B: 68

RF11061 is presented as primary test data for the use of CS Group PVC edge protectors and Acrovyn faces, as detailed in sections 5.4.1 and 5.5.1.

IF11010B	2No. ULSADD	All leaves: 2100	Integrity: A: 64 B: 64
		226 54	Insulation: A: 64 B: 64

IF11010B is presented as supporting documentation for the use of CS Group PVC edge Acrovyn faces, as detailed in section 5.5.1.

IF13095 Revision A	ULSADD	1400 900/300 57	Integrity: Insulation:	60 60
IF13095 Revision A is presented as supporting documentation for the use of CS Group PVC edge protectors and Acrovyn faces, as detailed in sections 5.4.1 and 5.5.1.				
RF07141 Rev B	2No. ULSADD	Both specimens: 2045 850/323 54	Integrity:	A: 62 B: 67
			Insulation:	A: 62 B: 67
RF07141 Rev B is presented as supporting documentation for the use of Yeoman Shield/Lorient PVCu Edge Protectors, as detailed in section 5.4.2.				
WF68330/B	Air Transfer Grilles in sections of door leaf	A: LV40 – 300 x 300 B: LV25 – 450 x 450	Integrity:	A: 65 B: 85
WF68330/B is presented in support of the Lorient Polyproducts air transfer grilles in section 10.9.7				
CF5688	Certifire Certificate in support of Lorient Polyproducts Ltd RJ008 Letter plates as detailed in section 10.9.8			
330936	A: LSASD	2040 930 54	Integrity Insulation	47 47
330936 is presented as supporting data for the use of the Record DFA127 closer discussed in section 10.7.1				
WF391351 (Mann McGowan Air transfer grilles)	B: LSASD	2040(h) x 926 (w) x 54(t)	BS EN 1634- 1:2014	69
WF391351 is presented as supporting data for the use of the Mann McGowan Air transfer grilles discussed in section 10.9.7.3				

4 Technical Specification

4.1 General

The technical specification for the proposed door assemblies is given in the following sections and is based on the test evidence for the door designs, summarised in section 3 and appendices A & C.

4.2 Intended Use

The intended use of the proposed door assembly is summarised below:

A pedestrian doorset including any frame, door leaf or leaves which is provided to give a fire resisting capability when used for the closing of permanent openings in fire resisting separating elements, which together with the building hardware and any seals (whether provided for the purpose of fire resistance or smoke control or for other purposes such as draught or acoustics) form the assembly.

4.3 Door Leaf

Doorsets constructed using the different leaf options can include various design features as summarised below.

Specific sections within this assessment must be referred to for design limitations and construction requirements.

Section 5 gives the description of each leaf construction in terms of composition and density etc.

4.3.1 Flamebreak 660 Plywood Faced– 54mm thick

The door designs can include:

1. Glazing
2. Various hardware options
3. Decorative facings
4. Decorative planted on timber mouldings
5. Edge Protectors
6. Overpanels, Fanlights & Sidelights.

4.3.2 Flamebreak FF660 MDF Faced– 54mm thick

The door designs can include:

1. Glazing
2. Various hardware options
3. Decorative facings
4. Decorative planted on timber mouldings.
5. Edge Protectors
6. Overpanels, Fanlights & Sidelights.

4.4 Door Frames

The construction of the door frames is hardwood with minimum frame dimensions. For further information on the specification and construction of the door frames see section 7.

Specific sections within this assessment must be referred to for design limitations and construction requirements, where applicable.

4.5 Doorset Configurations & Maximum Leaf Sizes

4.5.1 General

The evaluation of the leaf size for each door leaf option and frame option and doorset configuration is based on the tests listed in Section 3 and takes into account.

1. The margin of over performance above 60 minutes integrity for the design
2. The characteristics exhibited during test and
3. The doorset configuration tested.

The evaluation of the permitted configurations included in this field of application is based on the configuration(s) tested. The principle is that the more components included in testing, for example, double door leaves and an overpanel – the harder it becomes to pass a test. In this specific example it is because the junction between two door leaves or door leaf and overpanel introduces a discontinuity into the doorset which can be a means of failure. This approach leads to the following statements:

1. A test on a double doorset is more onerous than a test on a single doorset.
2. A test on an unlatched doorset is more onerous than a test on a latched doorset as the leading edge is unrestrained and will deflect more in fire test conditions.
3. A test on an unlatched single acting doorset is considered to be equivalent to a double acting doorset, due to the known deflection of an unlatched single acting doorset towards the furnace conditions i.e. away from the door stop. However, this does not cover doorsets with flush overpanels.
4. A doorset with transomed overpanel is considered to perform comparably to a similar doorset without an overpanel. This is because the transom structurally separates the overpanel from the doorset.







The leaf size for each door leaf option and configuration is linked to the perimeter intumescent specification and frame option. The following section details the maximum leaf size for each door leaf option and configuration based on the intumescent specification and frame details tested.

Doorsets with reduced height and width dimensions from those tested are deemed to be less onerous. Therefore, doors with dimensions less than those given in the leaf size envelopes (for the relevant intumescent specification) in the following sections are covered and may be manufactured.

4.5.2 Configurations



4.5.2.1 Flamebreak 660 Ply Faced

The table below shows the permitted configurations for doorsets constructed using the Flamebreak 660 door blank design, with the abbreviation and full description of each configuration.

Doorset Configurations – Flamebreak 660 Ply Faced		
Depiction	Abbreviation	Description
	LSASD	Latched Single Acting Single Doorset
	ULSASD	Unlatched Single Acting Single Doorset
	DASD	Double Acting Single Doorset
	LSADD	Latched Single Acting Double Doorset
	ULSADD	Unlatched Single Acting Double Doorset
	DADD	Double Acting Double Doorset

4.5.2.2 Flamebreak FF660 MDF Faced

The table below shows the permitted configurations for doorsets constructed using the Flamebreak FF660 MDF faced door blank design, with the abbreviation and full description of each configuration.

Doorset Configurations – Flamebreak FF660 MDF Faced		
Depiction	Abbreviation	Description
	LSASD	Latched Single Acting Single Doorset
	ULSASD	Unlatched Single Acting Single Doorset

4.5.3 Orientation

All of the primary fire resistance tests for these designs were conducted with the doorset hung such that the door leaf opened towards the fire, which is considered the most onerous orientation in terms of fire resistance performance. Based on this testing, assessment is made that the doorsets to this design may be hung either away from or towards the fire risk side of the doorset. The rationale behind the direction of fire testing timber based doorsets opening towards the fire test conditions is further explained in Annex C of BS EN 1634-1:2014 +A1:2018.

4.5.4 Envelopes for each Configurations

The following sections detail the door leaf envelopes which indicate the permitted leaf sizes for the listed configurations based on the perimeter intumescent, door leaf option and door frame.

Unequal leaf double doorsets are covered by this assessment with no restriction on the smaller leaf dimensions providing it does not exceed the relevant leaf size envelope and is not smaller in width than 300mm.

For equal double doorsets both leaves must comply with the door leaf envelope size limitations.

A table of essential hardware is given in section 10.3 for each doorset configuration, as a minimum requirement for the doorset described. Changes to hardware can affect the intumescent specification and frame details which are subsequently considered for each specific hardware component, where required.

4.5.4.1 General Note on Intumescent Seals

- Intumescent seals are to be fitted centrally unless stated otherwise.
- Intumescent seals are fully interrupted at hardware locations unless stated otherwise.
- Intumescent seals must run the full length of the leaf edge, with seals forming tightly abutting corner joints where the leaf edges meet, unless stated otherwise.

4.5.4.2 Explanation for following sections

The performance of a doorset in terms of configuration and size is dependent on the leaf construction, perimeter intumescent used and frame type. These elements are not automatically interchangeable. The following sections present the envelopes for the Flamebreak 660 Ply faced and FF660 MDF faced door blank leaf types in hardwood door frames. Each envelope is linked to a specific perimeter intumescent which is given a unique reference and is based directly on test evidence.

The envelopes are presented as follows:

- for LSASD increasing in configuration complexity up to ULSADD/DADD
- for each configuration, each leaf construction is considered separately.
- for each configuration, leaf construction, frame type the intumescent specification is considered separately and a unique envelope of permitted leaf sizes is presented based on the configuration, leaf construction, frame type and intumescent and the envelope is directly linked to a unique test.

4.5.5 LSASD Configuration: Leaf Sizes & Intumescent Specification Flamebreak 660 Ply Faced

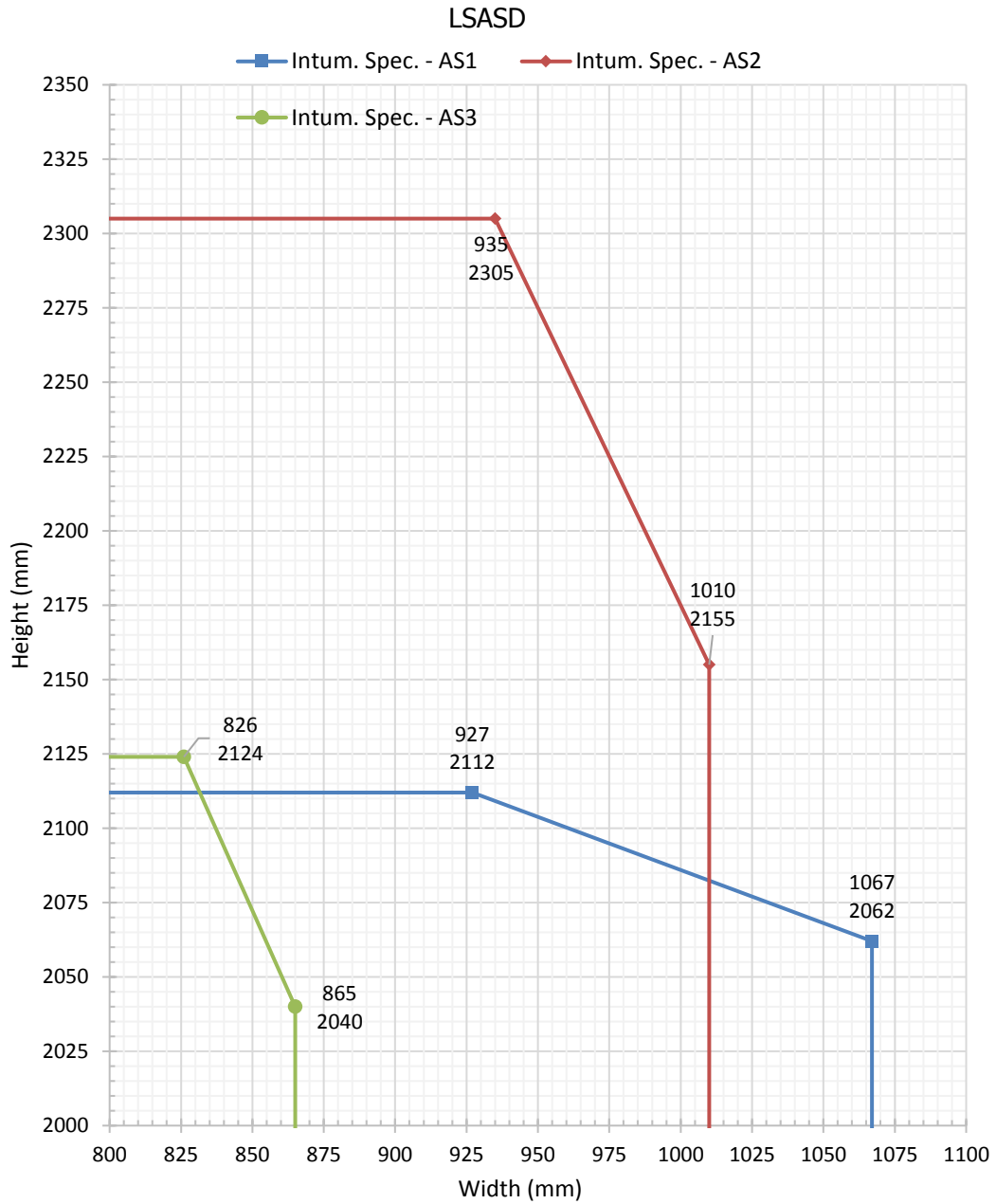

Intumescent Specification for LSASD			
Flamebreak 660 Ply Faced			
Intumescent Spec. Reference & (Test Reference)	Make / Type	Manufacturer / Supplier	Location & Size
AS1 (RF02054)	PVC encased Type 617	Lorient Polyproducts Ltd	Head: 1No. 30 x 4mm seal fitted centrally in the frame reveal Jambs: 2No. 15 x 4mm seals fitted centrally 10mm apart in the frame reveal
AS2 (RF02117)	Pyrostrip 500P	Mann McGowan Fabrications Ltd	Head: 1No. 30 x 4mm seal fitted centrally in the frame reveal Jambs: 2No. 15 x 4mm seals fitted centrally 10mm apart in the frame reveal
AS3 (RF08117 Revision A)	Rigid Box Seals	Pyroplex Ltd	Head & Jambs: 2no 15 x 4 mm seals fitted centrally in the frame reveals 10mm apart

4.5.6 ULSASD Configuration: Leaf Sizes & Intumescent Specification Flamebreak 660 Ply Faced

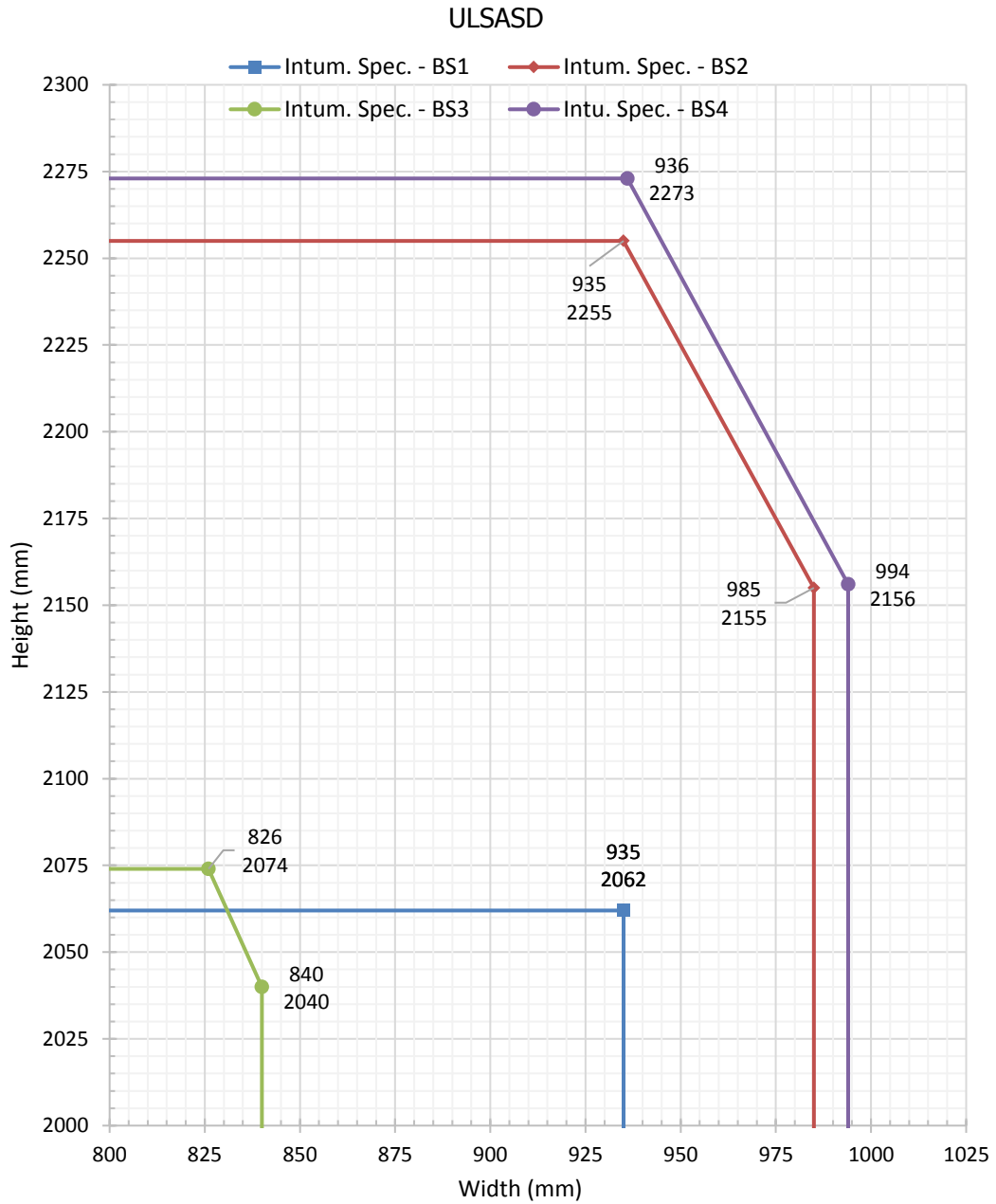

Intumescent Specification for ULSASD			
Flamebreak 660 Ply Faced			
Intumescent Spec. Reference & (Test Reference)	Make / Type	Manufacturer / Supplier	Location & Size
BS1 (RF02054)	PVC encased Type 617	Lorient Polyproducts Ltd	Head: 1No. 30 x 4mm seal fitted centrally in the frame reveal Jambs: 2No. 15 x 4mm seals fitted centrally 10mm apart in the frame reveal
BS2 (RF02117)	Pyrostrip 500P	Mann McGowan Fabrications Ltd	Head: 1No. 30 x 4mm seal fitted centrally in the frame reveal Jambs: 2No. 15 x 4mm seals fitted centrally 10mm apart in the frame reveal
BS3 (RF08117 Revision A)	Rigid Box Seals	Pyroplex Ltd	Head & Jambs: 2no 15 x 4 mm seals fitted centrally in the frame reveals 10mm apart
BS4 (WF307381)	Rigid Box Seals	Pyroplex Ltd	Head & Jambs: 2no 15 x 4 mm seals fitted centrally in the frame reveals 5mm apart This intumescent specification and leaf size envelope is only permitted for single acting doorsets hung on min. number 3 hinges with a face fixed self-closer (no other edge mounted hardware is permitted)

4.5.7 LSASD Configuration: Intumescent Specification Flamebreak 660 Ply Faced - Large Leaf Sizes

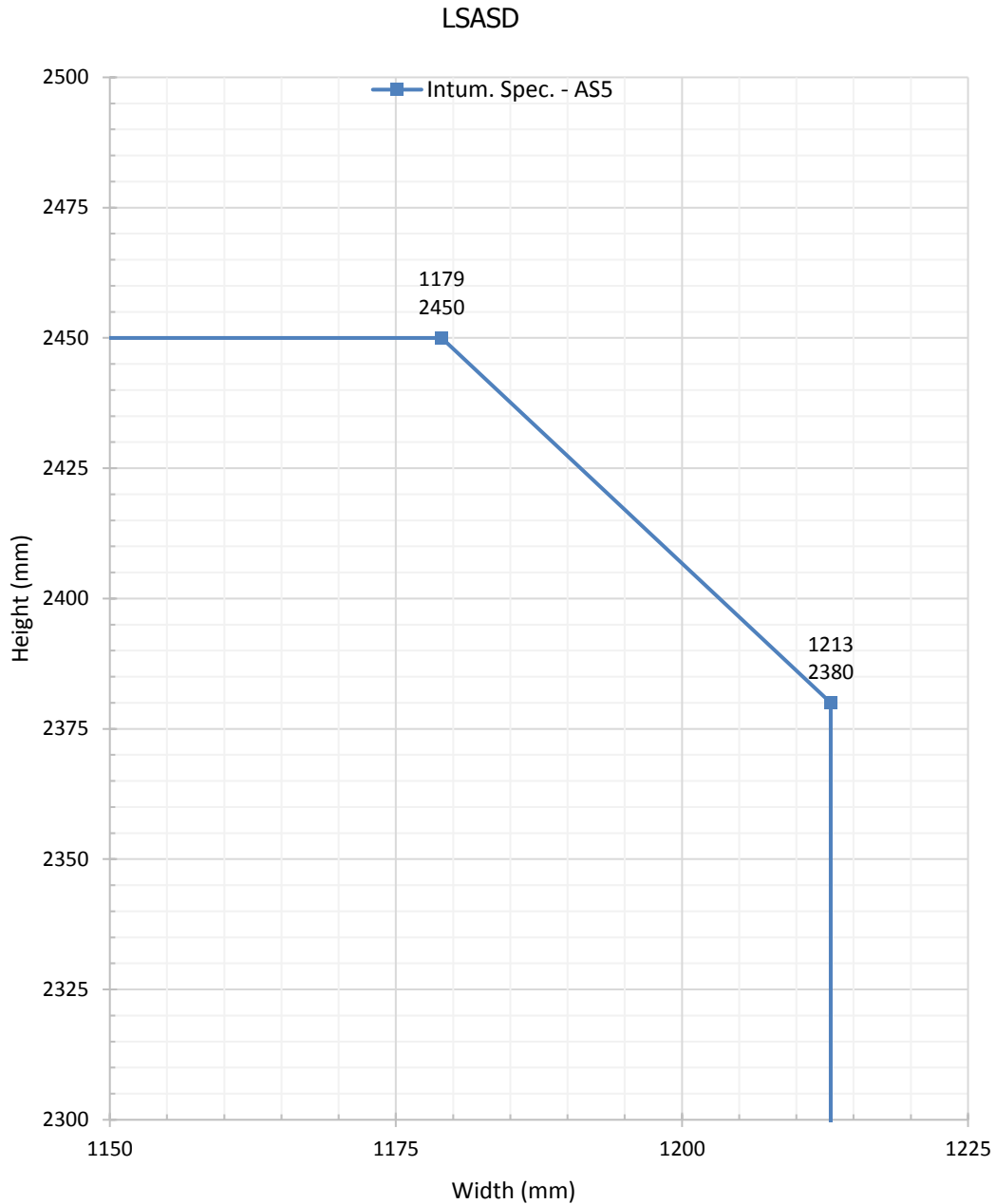

Intumescent Specification for LSASD Large Leaves Flamebreak 660 Ply Faced			
Intumescent Spec. Reference & (Test Reference)	Make / Type	Manufacturer / Supplier	Location & Size
AS5 (RF02117)	Pyrostrip 500P	Mann McGowan Fabrications Ltd	Head & Jamb: 2no 15 x 4 mm seals fitted centrally in the frame reveals 10mm apart

4.5.8 ULSASD & DASD Configurations - Leaf Sizes & Intumescent Specification

Flamebreak 660 Ply Faced - Large Leaf Sizes

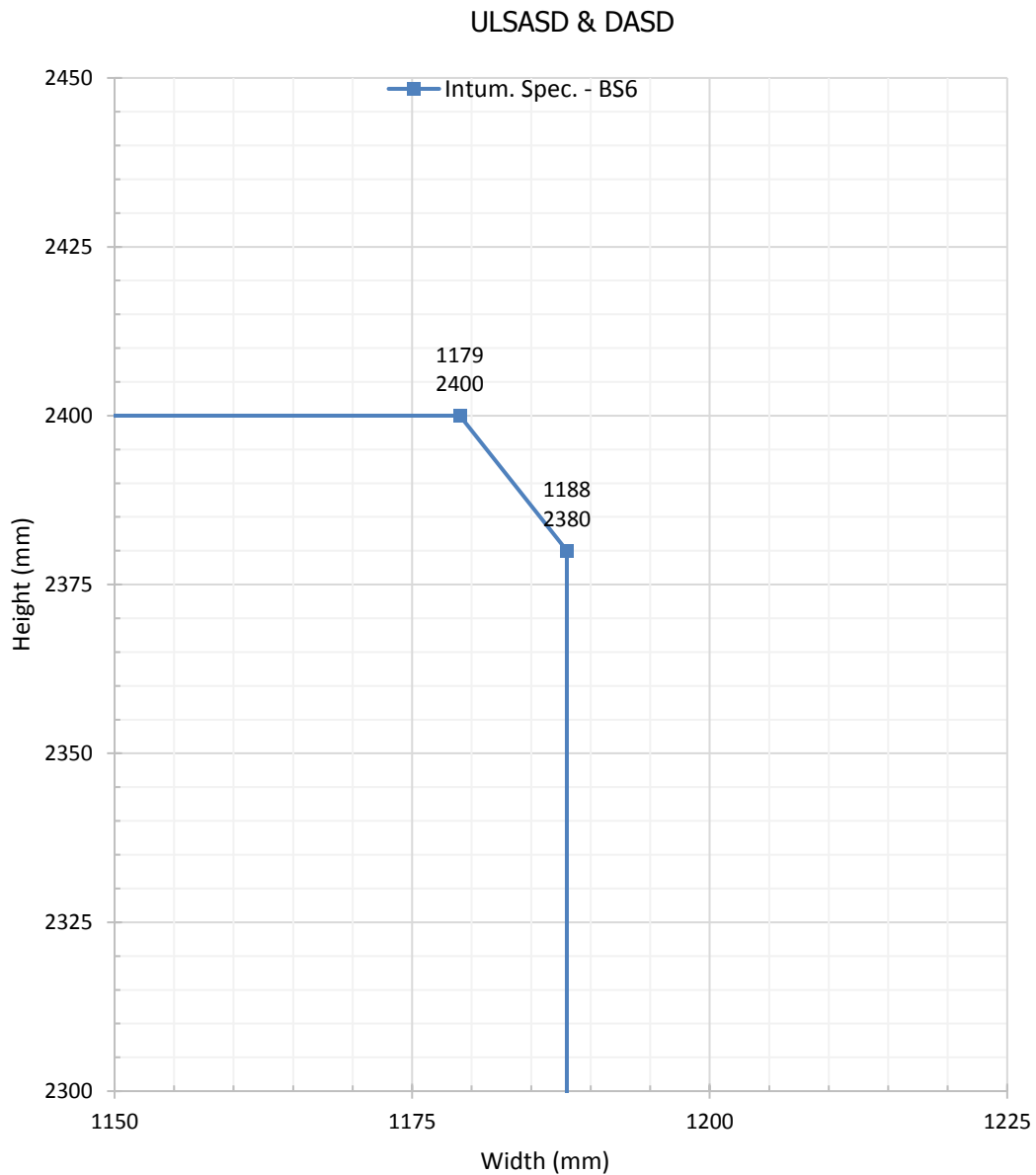

Intumescent Specification for ULSASD Flamebreak 660 Ply Faced			
Intumescent Spec. Reference & (Test Reference)	Make / Type	Manufacturer / Supplier	Location & Size
BS6* (RF02117)	Pyrostrip 500P	Mann McGowan Fabrications Ltd	Head & Jambs: 2no 15 x 4 mm seals fitted centrally in the frame reveals 10mm apart

Note * see section 10.2 for details of required hardware protection.

4.5.9 DASD Configuration: Leaf Sizes & Intumescent Specification

Flamebreak 660 Ply Faced

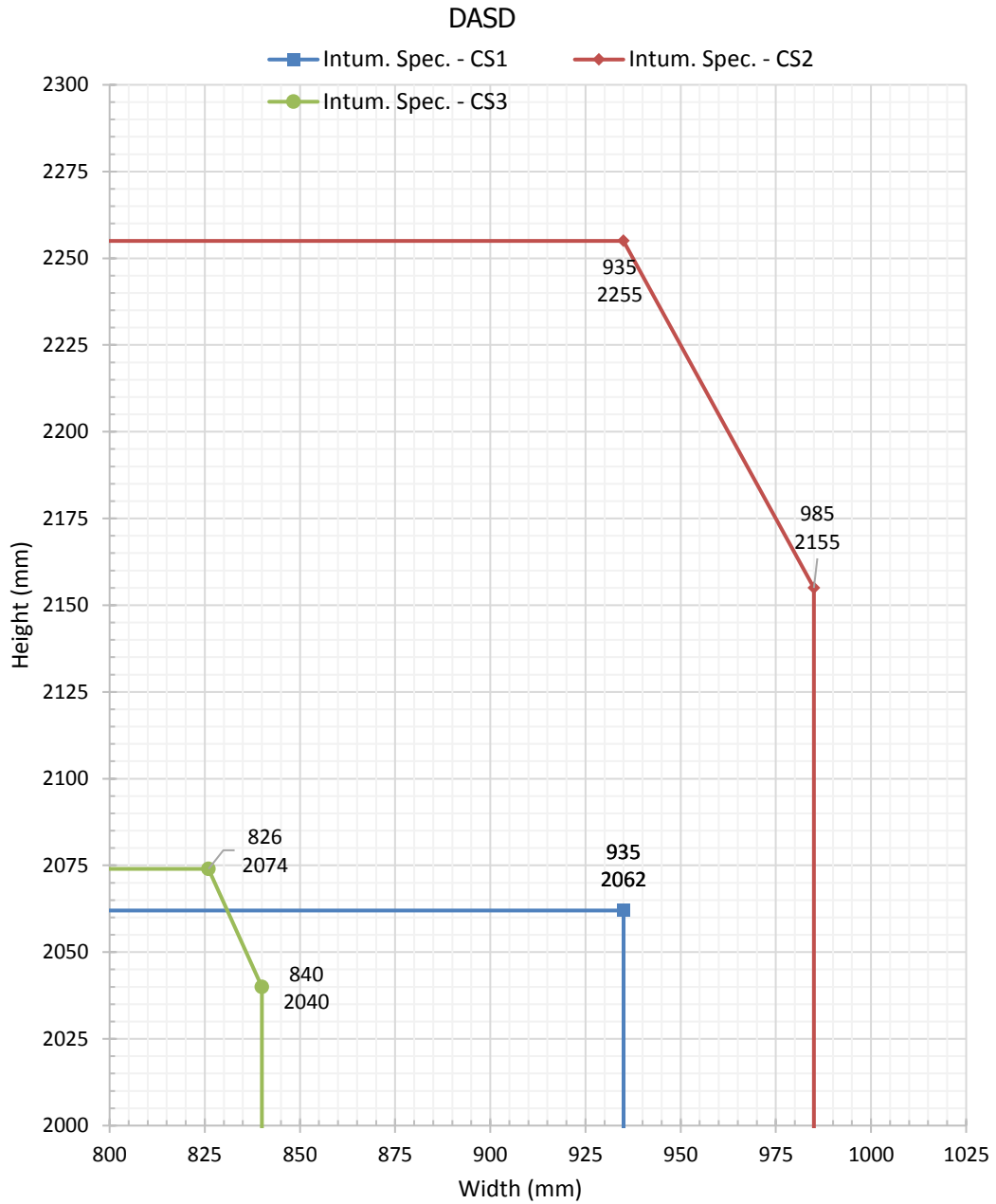

Intumescent Specification for DASD Flamebreak 660 Ply Faced			
Intumescent Spec. Reference & (Test Reference)	Make / Type	Manufacturer / Supplier	Location & Size
CS1* (RF02054)	PVC encased Type 617	Lorient Polyproducts Ltd	Head: 1No. 30 x 4mm seal fitted centrally in the frame reveal Jambs: 2No. 15 x 4mm seals fitted centrally 10mm apart in the frame reveal
CS2* (RF02117)	Pyrostrip 500P	Mann McGowan Fabrications Ltd	Head: 1No. 30 x 4mm seal fitted centrally in the frame reveal Jambs: 2No. 15 x 4mm seals fitted centrally 10mm apart in the frame reveal
CS3* (RF08117 Revision A)	Rigid Box Seals	Pyroplex Ltd	Head & Jambs: 2no 15 x 4 mm seals fitted centrally in the frame reveals 10mm apart

Note * see section 10.2 for details of required hardware protection.

4.5.10 LSASD Configuration: Intumescent Specification - Multipoint Lockset Flamebreak 660 Ply Faced

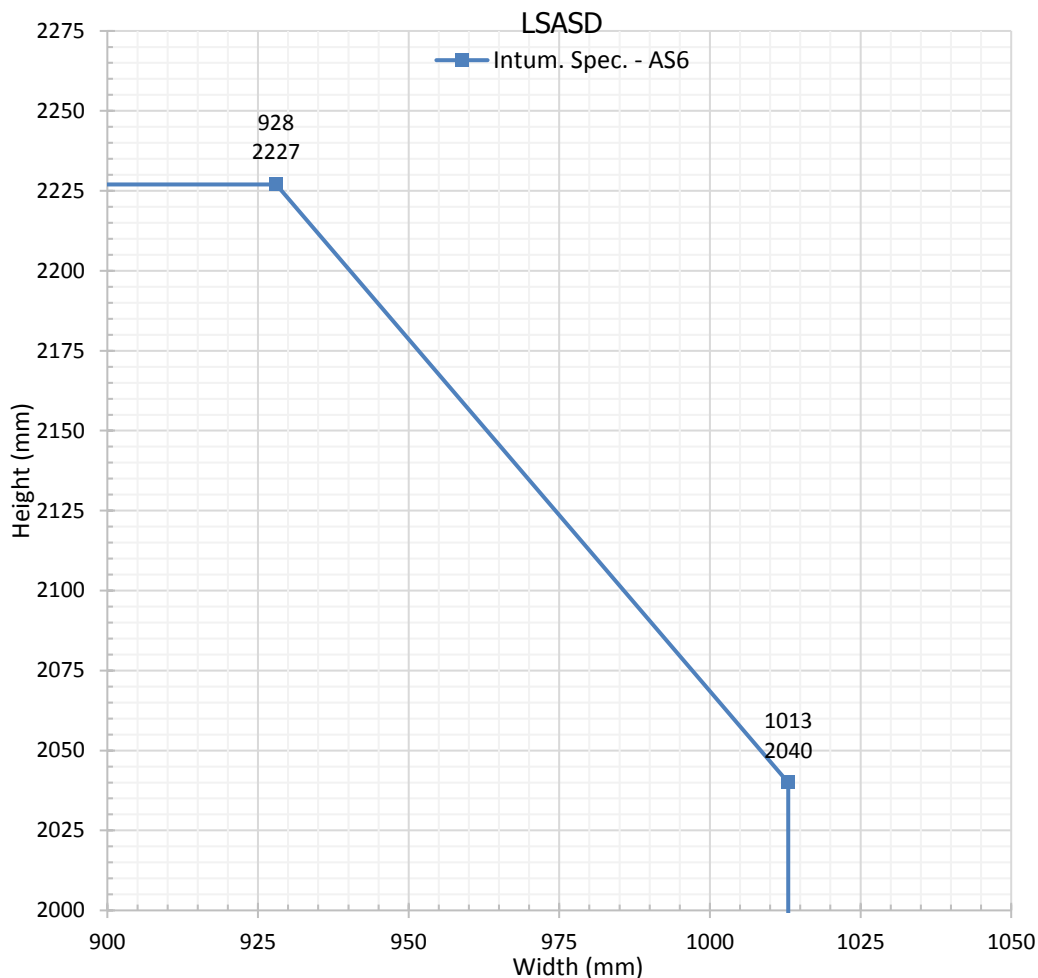

The graph above shows the maximum assessed leaf dimensions permitted when specifying door assemblies incorporating multipoint locksets, based on the results of test WF408272 AR1. Leaves may be manufactured at any dimensions below the graph line provided the leaf internal framing as detailed in section 5.1.1 is included during manufacture. See section 10.4.2 for installation details relating to the multipoint lock.

Intumescent Specification for LSASD Multipoint lockset Flamebreak 660 Ply Faced			
Intumescent Spec. Reference & (Test Reference)	Make / Type	Manufacturer / Supplier	Location & Size
AS6 (WF408272 AR1)	ST154	Sealed Tight Solutions Ltd	Leaf: 1no 15 x 4 mm seal fitted centrally in the leaf head Frame, Head & Jamb: 2no 15 x 4 mm seals fitted centrally in the frame reveals 12mm apart

4.5.11 LSADD Configuration: Leaf Sizes & Intumescent Specification

Flamebreak 660 Ply Faced



Intumescent Specification for LSADD Flamebreak 660 Ply Faced			
Intumescent Spec. Reference & (Test Reference)	Make / Type	Manufacturer / Supplier	Location & Size
DD1 (RF02055)	Pyrostrip 500P	Mann McGowan Fabrications Ltd	<p>Head: 1No. 30 x 4mm seal fitted centrally in the frame reveal</p> <p>Jams: 2No. 15 x 4mm seals fitted centrally 10mm apart in the frame reveal</p> <p>Meeting Edges: 2No. 15 x 4mm seals fitted centrally 10mm apart in one meeting edge only (edge with lock case)</p>

4.5.12 ULSADD Configuration: Leaf Sizes & Intumescent Specification

Flamebreak 660 Ply Faced

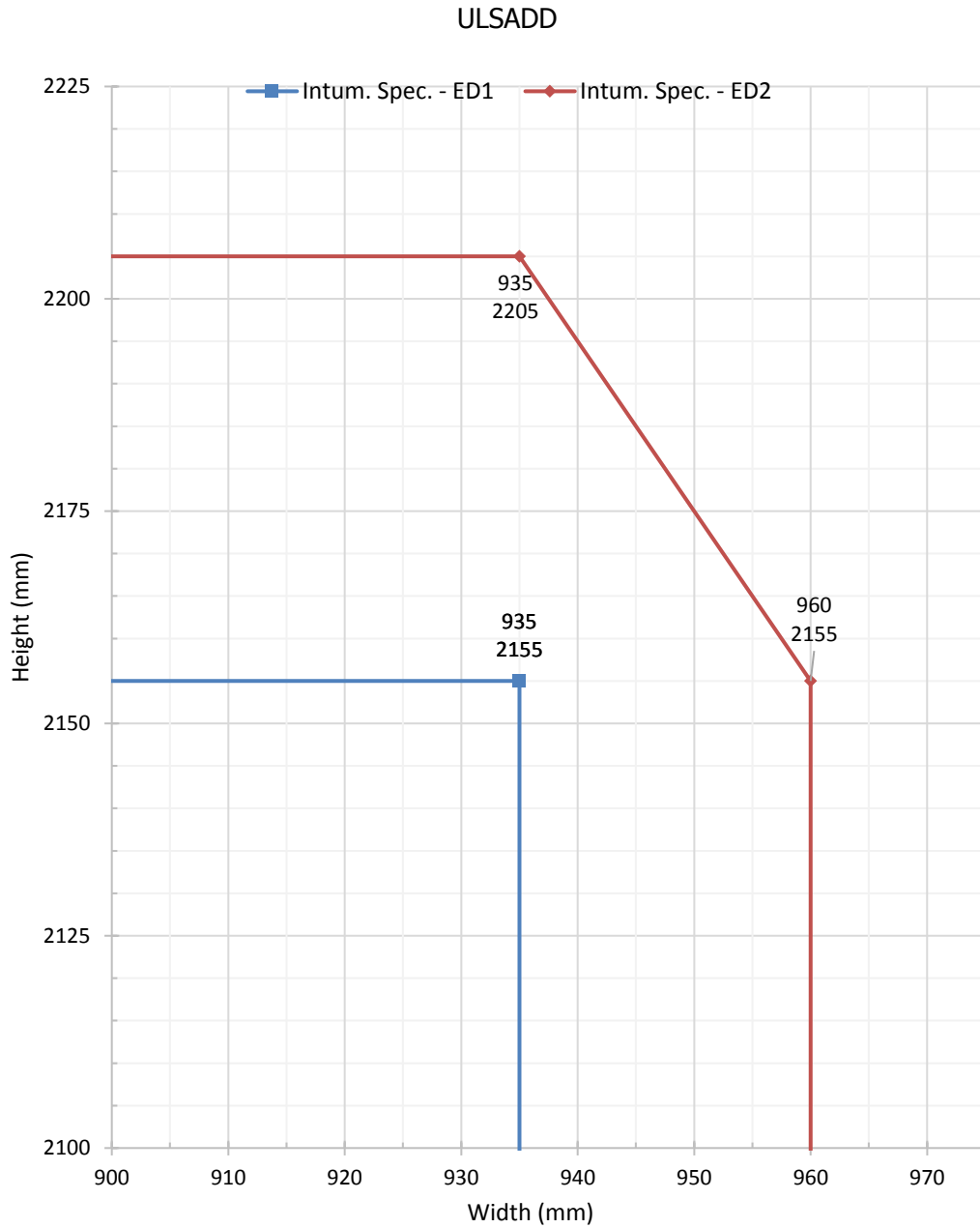

Intumescent Specification for ULSADD Flamebreak 660 Ply Faced			
Intumescent Spec. Reference & (Test Reference)	Make / Type	Manufacturer / Supplier	Location & Size
ED1 (WF307381)	Rigid Box Seals	Pyroplex Ltd	<p>Head & Jambs: 2No. 15 x 4mm seals fitted centrally 5 mm apart in the frame reveals</p> <p>Meeting Edges: 2No. 15 x 4mm seals fitted centrally 5mm apart in one meeting edge only.</p> <p>This intumescent specification and leaf size envelope is only permitted for single acting doorsets hung on min. number 3 hinges with a face fixed self-closer (no other edge mounted hardware is permitted)</p>
ED2 (RF02055)	Pyrostrip 500P	Mann McGowan Fabrications Ltd	<p>Head: 1No. 30 x 4mm seal fitted centrally in the frame reveal</p> <p>Jambs: 2No. 15 x 4mm seals fitted centrally 10mm apart in the frame reveal</p> <p>Meeting Edges: 2No. 15 x 4mm seals fitted centrally 10mm apart in one meeting edge only (edge with lock case)</p>

4.5.13 DADD Configuration: Leaf Sizes & Intumescent Specification Flamebreak 660 Ply Faced

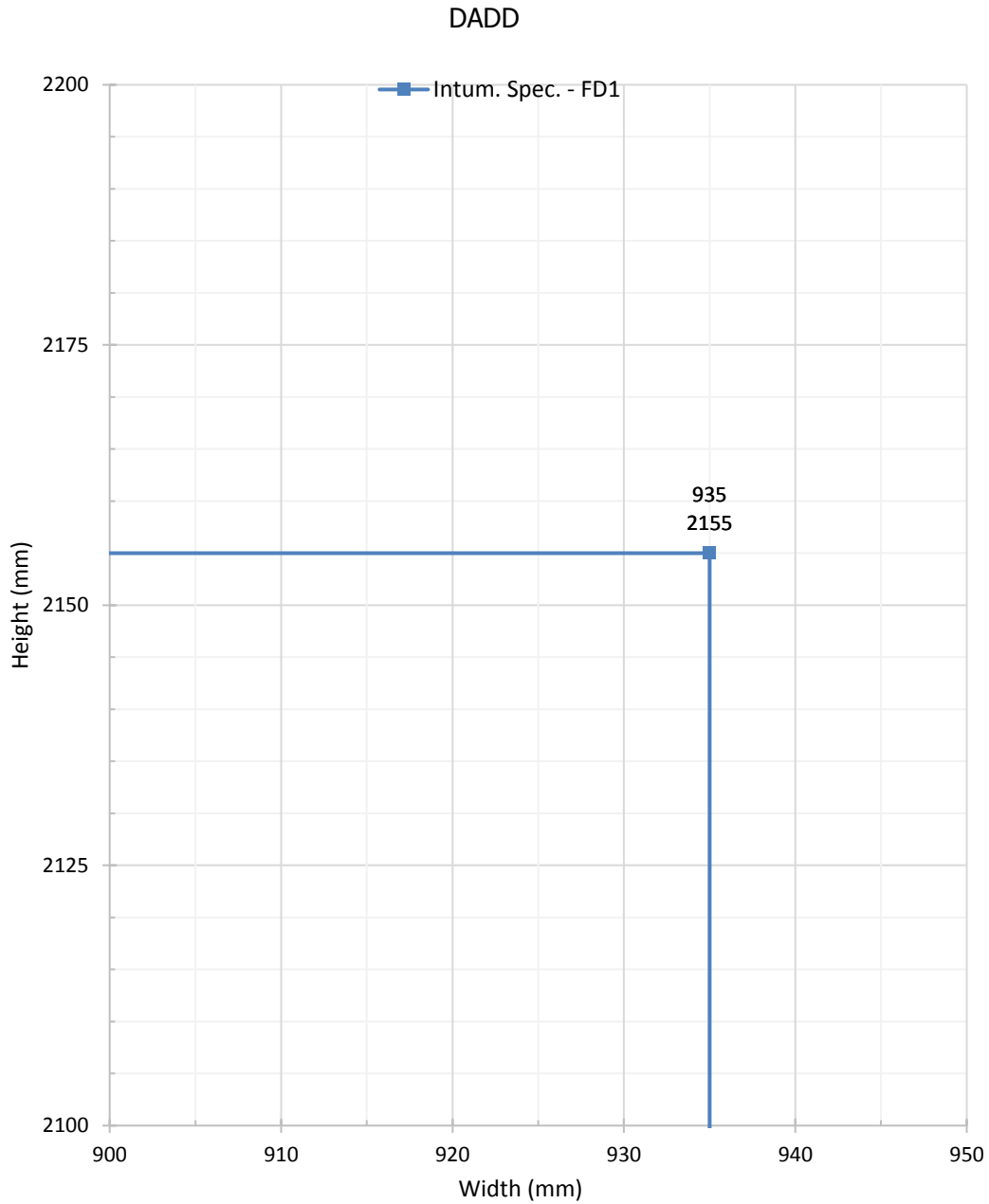

Intumescent Specification for DADD Flamebreak 660 Ply Faced			
Intumescent Spec. Reference & (Test Reference)	Make / Type	Manufacturer / Supplier	Location & Size
FD1* (RF02055)	Pyrostrip 500P	Mann McGowan Fabrications Ltd	Head: 1No. 30 x 4mm seal fitted centrally in the frame reveal Jams: 2No. 15 x 4mm seals fitted centrally 10mm apart in the frame reveal Meeting Edges: 2No. 15 x 4mm seals fitted centrally 10mm apart in one meeting edge only (edge with lock case)

Note * see section 10.2 for details of required hardware protection.

4.5.14 LSASD, ULSASD & DASD - CS Edge Protectors/Acrovyn Wrap Leaf Sizes & Intumescent Specification Flamebreak 660 Ply Faced

LSASD, ULSASD & DASD

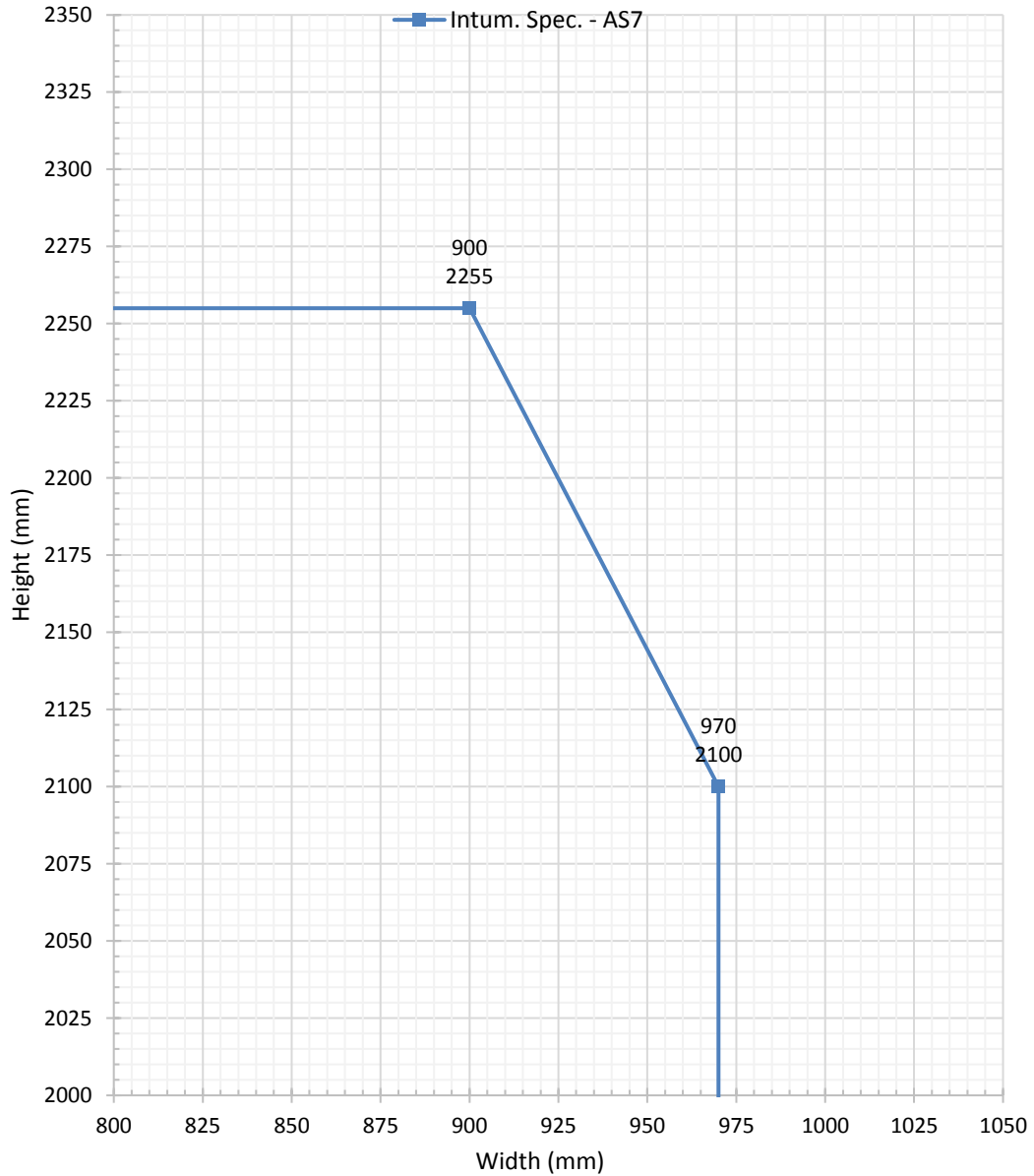

Intumescent Specification for LSASD, ULSASD & DASD CS Edge Protectors/Acrovyn Wrap Flamebreak 660 Ply Faced			
Intumescent Spec. Reference & (Test Reference)	Make / Type	Manufacturer / Supplier	Location & Size
AS7* (RF11061)	PVC encased Type 617	Lorient Polyproducts Ltd	Head: 2No. 15 x 4mm seals fitted centrally 10mm apart in the frame reveal Jams: 2No. 15 x 4mm seals fitted 10mm apart centrally in the frame reveal, in addition to the CS edge protectors with integral intumescents fitted on the leaf edges.

Note * see section 10.2 for details of required hardware protection.

4.5.15 LSADD, ULSADD & DADD - CS Edge Protectors/Acrovyn Wrap Leaf Sizes & Intumescent Specification Flamebreak 660 Ply Faced

LSADD, ULSADD & DADD

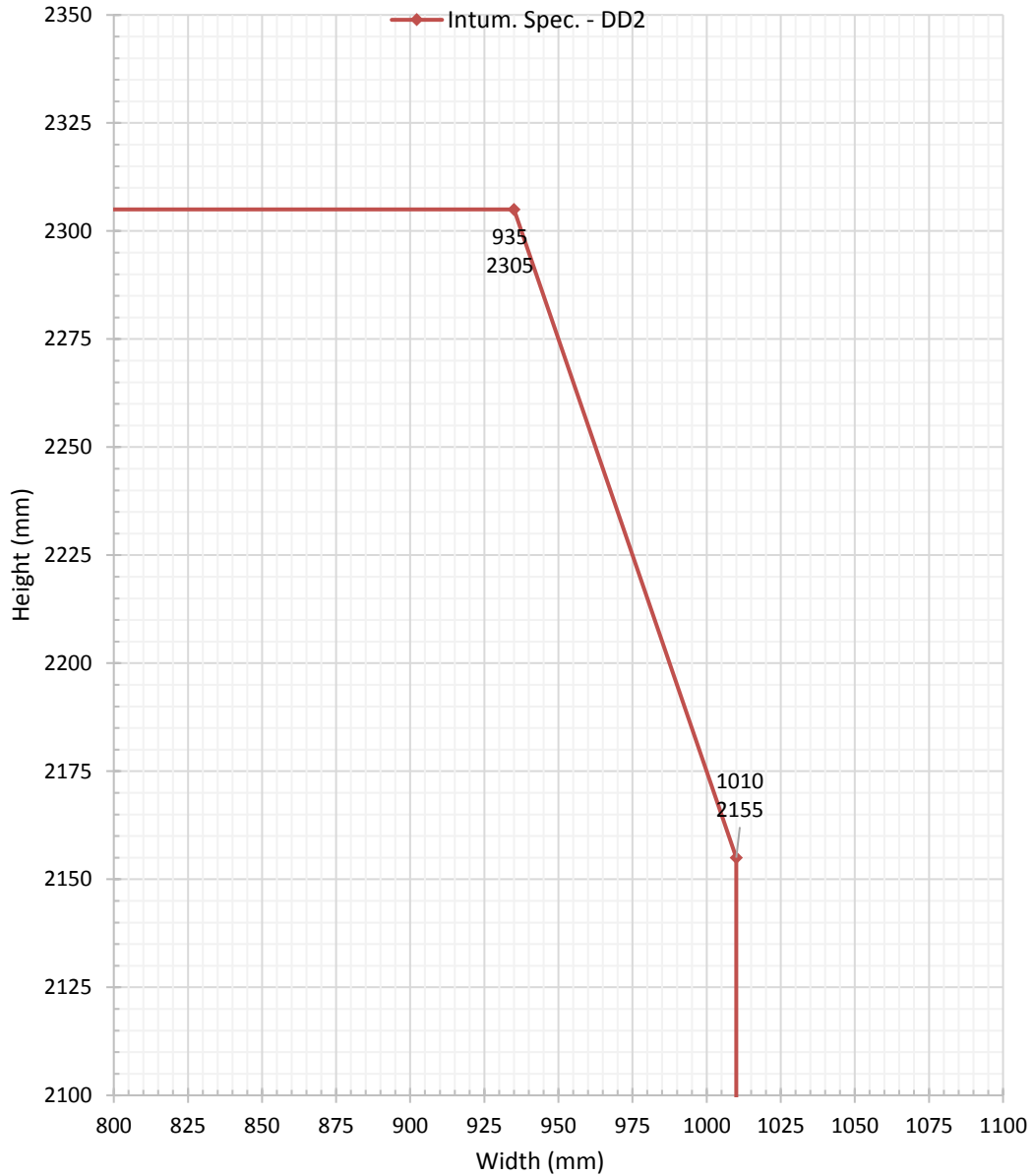

Intumescent Specification for LSADD, ULSADD & DADD CS Edge Protectors/Acrovyn Wrap Flamebreak 660 Ply Faced			
Intumescent Spec. Reference & (Test Reference)	Make / Type	Manufacturer / Supplier	Location & Size
DD2* (RF11061)	PVC encased Type 617	Lorient Polyproducts Ltd	Head: 2No. 15 x 4mm seals fitted centrally 10mm apart in the frame reveal Jams: 2No. 15 x 4mm seals fitted 10mm apart centrally in the frame reveal, in addition to the CS edge protectors with integral intumescents fitted on the leaf edges. Meeting Edges: 1No. 15 x 4mm seal fitted centrally in the CS edge protectors fitted to the meeting edge of both leaves.

Note * see section 10.2 for details of required hardware protection.

4.5.16 LSASD, ULSASD & DASD - Yeoman Shield/Lorient Edge Protectors Leaf Sizes & Intumescent Specification Flamebreak 660 Ply Faced

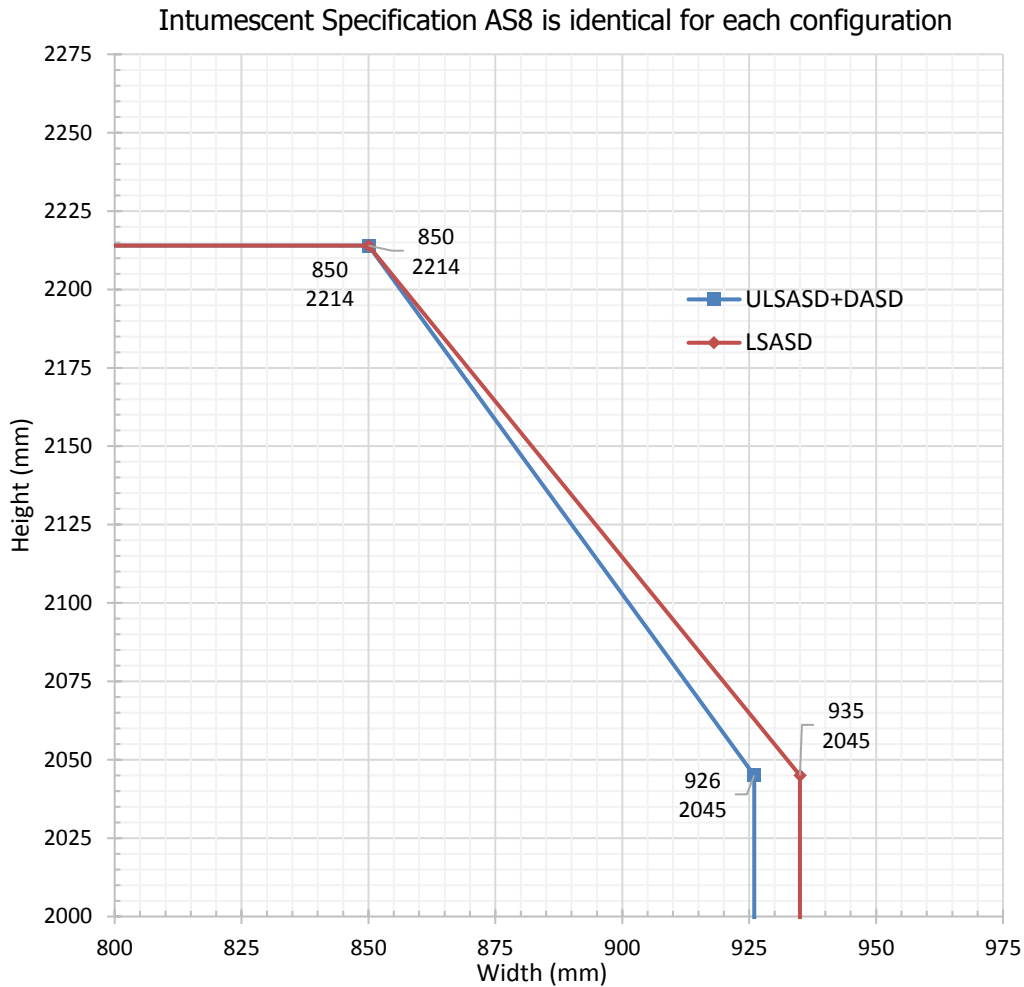

Intumescent Specification for LSASD, ULSASD & DASD Yeoman Shield/Lorient Edge Protectors Flamebreak 660 Ply Faced			
Intumescent Spec. Reference & (Test Reference)	Make / Type	Manufacturer / Supplier	Location & Size
AS8* (RF07141 Rev B)	PVC encased Type 617	Lorient Polyproducts Ltd	Head: 2No. 15 x 4mm seals fitted centrally 10mm apart in the frame reveal. Jams: 1No. 20 x 4mm seal fitted centrally in the Yeoman Shield/Lorient door edge protector

Note * see section 10.2 for details of required hardware protection.

4.5.17 LSADD, ULSADD & DADD - Yeoman Shield/Lorient Edge Protectors Leaf Sizes & Intumescent Specification Flamebreak 660 Ply Faced

Intumescent Specification D3 is identical for each configuration

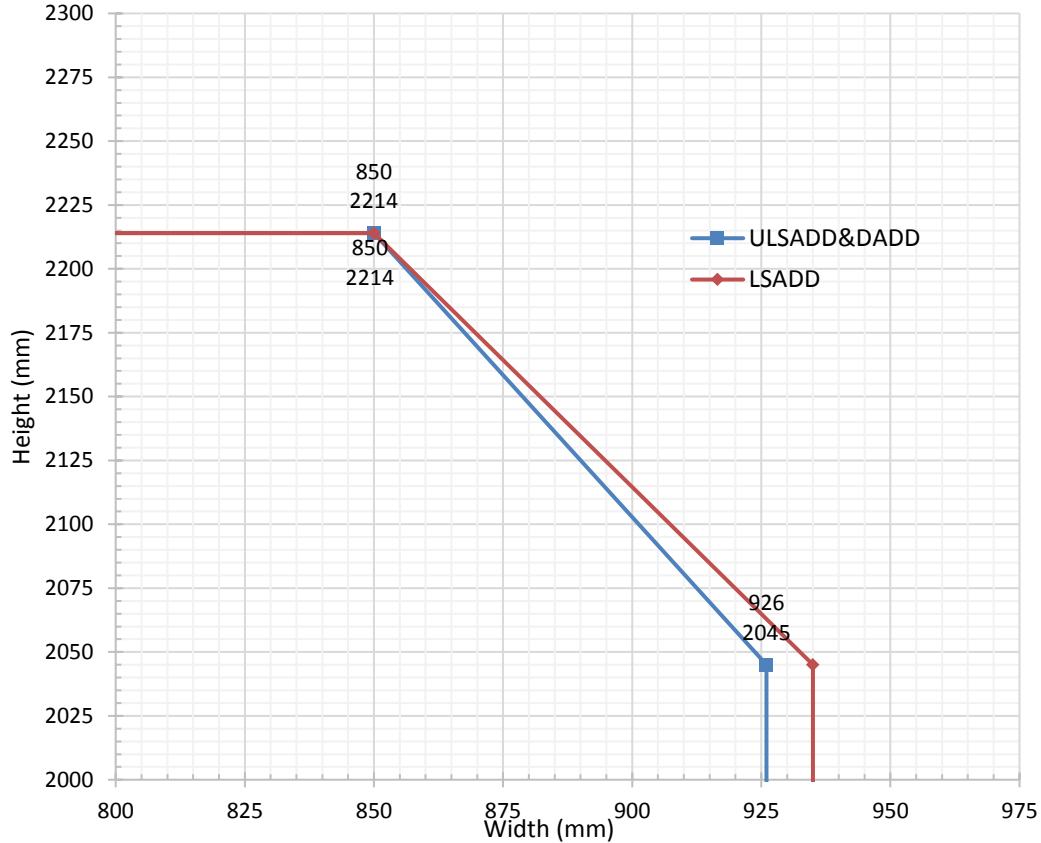

Intumescent Specification for LSADD, ULSADD & DADD Yeoman Shield/Lorient Edge Protectors Flamebreak 660 Ply Faced			
Intumescent Spec. Reference & (Test Reference)	Make / Type	Manufacturer / Supplier	Location & Size
DD3* (RF07141 Rev B)	PVC encased Type 617	Lorient Polyproducts Ltd	Head: 2No. 15 x 4mm seals fitted centrally 10mm apart in the frame reveal Jamb: 1No. 20 x 4mm seal fitted centrally in the Yeoman Shield/Lorient door edge protector Meeting Edges: 1No. 20 x 4mm seal fitted centrally in the Yeoman Shield/Lorient door edge protectors of both leaves.

Note * see section 10.2 for details of required hardware protection.

4.5.18 LSASD Configuration: Leaf Sizes & Intumescent Specification Flamebreak FF660 MDF Faced



Intumescent Specification for LSASD			
FF660 MDF Faced			
Intumescent Spec. Reference & (Test Reference)	Make / Type	Manufacturer / Supplier	Location & Size
AS10 (WF503863)	Pyrostrip 500P	Mann McGowan Fabrications Ltd	Head & Jambs: 2no 15 x 4 mm seals fitted centrally in the frame reveals 10mm apart
AS11 (WF532372 Doorset A)	Type617 LP1504	Lorient Polyproducts Ltd	Head & Jambs: 2no 15 x 4 mm seals fitted centrally in the frame reveals 10mm apart
AS12 (WF532372 Doorset B)	Rigid Box Seal	Pyroplex Ltd	Head & Jambs: 2no 15 x 4 mm seals fitted centrally in the frame reveals 10mm apart

4.5.19 ULSASD Configuration: Leaf Sizes & Intumescent Specification Flamebreak FF660 MDF Faced

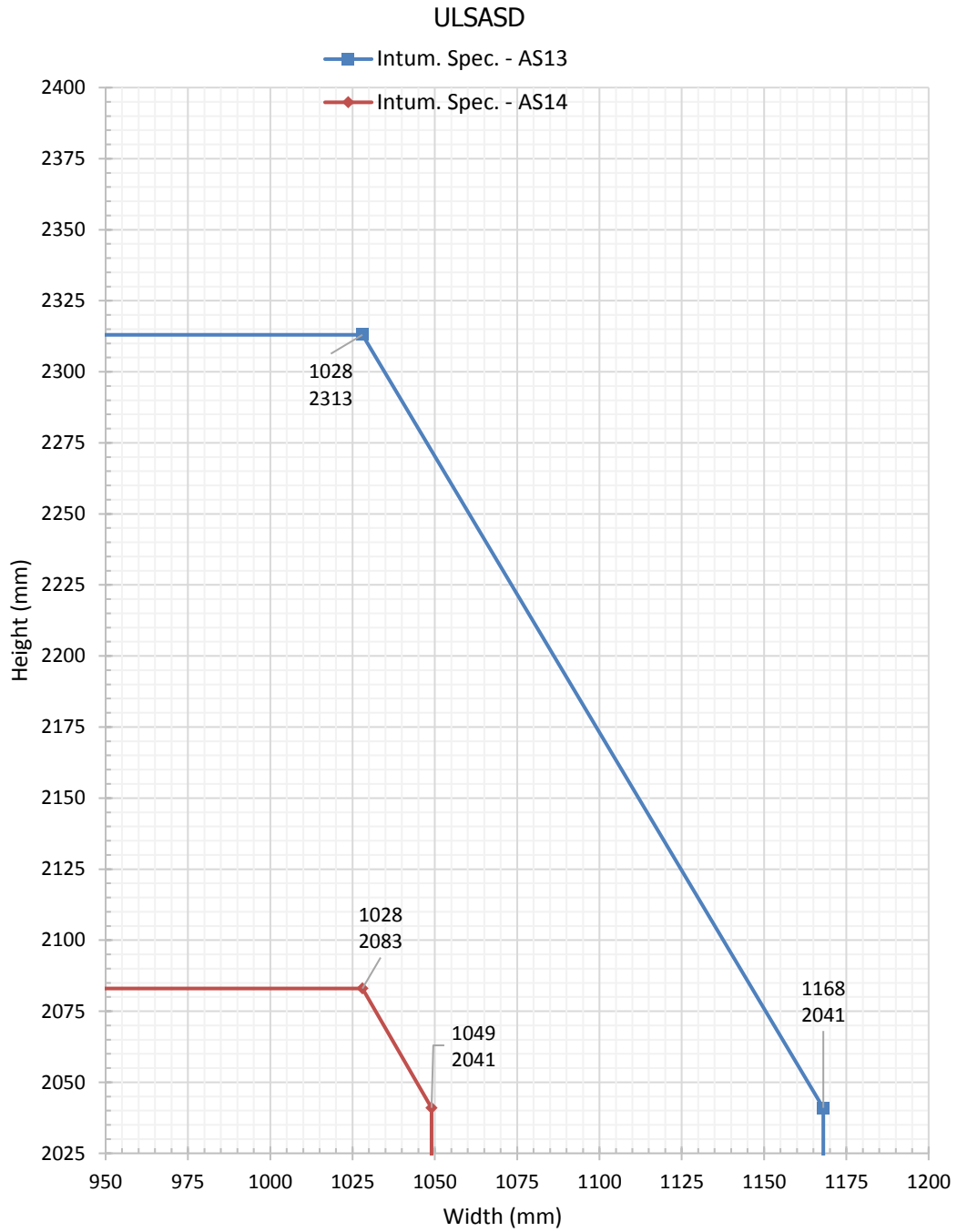

Intumescent Specification for ULSASD FF660 MDF Faced			
Intumescent Spec. Reference & (Test Reference)	Make / Type	Manufacturer / Supplier	Location & Size
AS13 (WF532372 Doorset A)	Type617 LP1504	Lorient Polyproducts Ltd	Head & Jambs: 2no 15 x 4 mm seals fitted centrally in the frame reveals 10mm apart
AS14 (WF532372 Doorset B)	Rigid Box Seal	Pyroplex Ltd	Head & Jambs: 2no 15 x 4 mm seals fitted centrally in the frame reveals 10mm apart

5 General Description of Leaf Construction

5.1 Leaf Core Construction

The two door blank options are detailed below and are approved by this assessment.

5.1.1 Flamebreak 660 Ply Faced

The basic tested construction of this door blank design comprises the following:

Element		Species/type	Configuration (all dims in mm)	Min. Density (kg/m ³)
Core – 3 layers	Outer layers	Parasoriantes falacateria or Albisia falcatta	Vertically orientated 13.5 thick x 45 ¹ wide lamels	180 - 360
	Inner layer	'Mixed tropical hardwood'	Horizontally orientated 15 thick x 28 wide lamels	480
Stiles		Mixed tropical hardwood in 1 or 2 lamels	35 wide (total) x 42 thick, incorporating a 9 x 9 tongue located into the core material	Mixed tropical hardwood - 610
Top Rail		Mixed tropical hardwood in 1, 2 or 3 lamels	75 ² wide (total) x 42 thick, incorporating a 9 x 9 tongue located into the core material	Mixed tropical hardwood – 610
Bottom Rail		Mixed tropical hardwood in 1 or 2 lamels	35 wide (total) x 42 thick, incorporating a 9 x 9 tongue located into the core material	Mixed tropical hardwood – 610
Facings		Plywood	6 thick	520
Lippings – all edges		Hardwood (excluding Beech (<i>Fagus sylvatica</i>))	Varies ³	640

Notes:

1. Lamels must be 45mm wide, a tolerance of -3mm/+0 (zero) mm is permitted.
2. Top rail must total a minimum 75mm wide, a tolerance of +5mm/-0 (zero) mm is permitted.
3. Flamebreak 660 ply faced must be lipped on all edges (see section 5.3).
4. For permitted leaf size adjustment of Flamebreak 660 ply faced see section 5.2 (section 11.6 gives information on leaf adjustment postproduction).
5. The permitted leaf size envelopes and intumescent specifications for Flamebreak 660 ply faced are given in section 4.5.
6. The minimum leaf thickness after calibration is 53mm (i.e. a maximum of 0.5mm from both sides).
7. The minimum leaf thickness after finishes applied is 54mm.

5.1.2 Flamebreak FF660 MDF Faced

The basic tested construction of this door leaf design comprises the following:

Element		Species/type	Configuration (all dims in mm)	Min. Density (kg/m ³)
Core – 3 layers	Outer layers	Parasoriantes falacateria or Albisia falcatta	Vertically orientated 13.5 thick x 45 ¹ wide lamels	180 - 360
	Inner layer	‘Mixed tropical hardwood’	Horizontally orientated 15 thick x 28 wide lamels	480
Stiles		Mixed tropical hardwood in 1 or 2 lamels	35 wide (total) x 42 thick, incorporating a 9 x 9 tongue located into the core material	Mixed tropical hardwood - 610
Top Rail		Mixed tropical hardwood in 1, 2 or 3 lamels	75 ² wide (total) x 42 thick, incorporating a 9 x 9 tongue located into the core material	Mixed tropical hardwood – 610
Bottom Rail		Mixed tropical hardwood in 1 or 2 lamels	35 wide (total) x 42 thick, incorporating a 9 x 9 tongue located into the core material	Mixed tropical hardwood – 610
Facings		MDF	6 thick	710
Lippings – all edges		Hardwood (excluding Beech (<i>Fagus sylvatica</i>))	Varies ³	640

Notes:

1. Lamels must be 45mm wide, a tolerance of -3mm/+0 (zero) mm is permitted.
2. Top rail must total a minimum 75mm wide, a tolerance of +5mm/-0 (zero) mm is permitted.
3. Flamebreak FF660 MDF faced must be lipped on all edges (see section 5.3).
4. For permitted leaf size adjustment of Flamebreak FF660 MDF faced see section 5.2 (section 11.6 gives information on leaf size adjustment postproduction).
5. The permitted leaf size envelopes and intumescent specifications for Flamebreak FF660 MDF faced are given in section 4.5.
6. The minimum leaf thickness after calibration is 53mm (i.e. a maximum of 0.5mm from both sides).
7. The minimum leaf thickness after finishes applied is 54mm.

5.2 Leaf Size Adjustment During Manufacturing

5.2.1 Flamebreak 660 Ply Faced

As noted in section 5.1, as standard Flamebreak 660 Ply faced is manufactured with stiles and rails as part of the construction. Test references RF02055 and WF374929 have proven that Flamebreak 660 Ply faced can be trimmed as described in the table below and still achieve fire resistance performance. Door leaves may be altered as follows prior to the machining for hardware.

Pre-Machining Leaf Size Adjustment Specification	
Element	Reduction
Leaf	The size of the leaf may be reduced in height or width without restriction for manufacturing purposes (subject to specific restrictions given in the notes below this table), providing the head rail remains in position and is trimmed no more than 3mm for calibration purposes. The finished leaf must be lipped on all edges in accordance with section 5.3
Timber Lipping	The timber lipping thickness can be reduced after it has been glued in place, providing it is not reduced below the minimum stated in section 5.3

Notes:

1. Recessed automatic drop-down seals must be fitted into a full width bottom rail.
2. Edge mounted recessed flush bolts must be fitted into full width stiles.
3. Locksets must be mounted into full width stiles for double leaf configurations.

5.2.2 Flamebreak FF660 MDF Faced

As noted in section 5.1, as standard Flamebreak FF660 MDF faced is manufactured with stiles and rails as part of the construction. The Flamebreak FF660 MDF faced has been tested in RF05042 and WF503863 Doorset A to show that the leaf can be reduced in dimensions but with more restrictions than the Flamebreak 660 ply faced design. Door leaves may be altered as follows prior to the machining for hardware.

Pre-Machining Leaf Size Adjustment Specification	
Element	Reduction
Leaf	The head rail and stiles must not be removed when constructing doorsets using the Flamebreak FF660 MDF faced design. Prior to lipping the stiles can be reduced by maximum 5mm and the head rail reduced by maximum 3mm. The bottom rail can be removed completely for leaf height adjustment (subject to specific restrictions given in the note below this table). The finished leaf must be lipped on all edges in accordance with section 5.3
Timber Lipping	The timber lipping thickness can be reduced after it has been glued in place, providing it is not reduced below the minimum stated in section 5.3

Notes:

1. Recessed automatic drop-down seals must be fitted into a full width bottom rail.

5.3 Timber Lipping – Flamebreak 660 Ply Faced and FF660 MDF Faced

The testing documented in section 3 and appendices A & C has generally been undertaken using 8-10mm thick lippings applied to all edges using species at varying densities. A number of different adhesives have also been used to affix the lippings.

Test WF532372 was undertaken to demonstrate that the use of ‘T-shaped’ lippings may be used as an alternative to flat lippings without being a cause of premature integrity failure. The test successfully demonstrated integrity performance with two of the intumescent seal types permitted for use in section 4.5. It is the assessment of Warringtonfire that the T-shaped lipping design, as sampled at the blank production factory successfully tested may be used as an alternative to flat lippings without restriction.

On the above basis, Flamebreak 660 Ply faced and FF660 MDF faced door blanks must be lipped with the following specification, for both leaf types and for solid panels (overpanels), where appropriate.

Timber Lipping Specification for Flamebreak 660 Ply Faced and FF660 MDF Faced door blanks		
Material	Size(mm)	Min Density (kg/m ³)
Hardwood (not Beech - <i>fagus species</i>).	Flat = 8 – 15 thick with a maximum of 2mm profiling permitted at corners of lipping (see section 7.1) T-shaped = 54 wide x 10 thick with 8 thick x 25 wide tongue into stiles and rails ⁵	640
	Rounded = 12 – 17 thick with a radius matching the distance between leaf edge and floor pivot (see section 7.1)	
	Rebated = Not permitted	

Notes:

1. All doorsets constructed using Flamebreak 660 Ply faced or FF660 MDF faced door blanks must be lipped on all four edges.
2. Lippings along the vertical edges must over-run the lippings along the horizontal edges.
3. The use of rebated meeting stiles for double doorsets is not approved.
4. The use of doorset designs with flush overpanels is not approved.
5. T-Shaped lippings may only be applied by P.T Kutai during blank manufacture.

5.3.1 Hardwood blocking for pivots – Flamebreak 660 Ply Faced Only

The following option is permitted for lipping the bottom of doors that are to receive pivot fixings and are to be used in severe duty locations (diagram below). It is not necessary to introduce additional blocking at the head of the door because of the presence of the integral top rail. The intention of the insert is to surround the pivot in the bottom of the door leaf.

The hardwood (minimum density 640kg/m³ excluding Beech (*Fagus species*)) insert must be nominally 15mm high by a length suitable for the hardware to be installed plus a maximum of 50mm (not full door width). The hardwood insert must be nominally 28mm wide and fitted centrally in the leaf leaving 8mm of leaf material on either face. The inserted block must be bonded on all contact faces using adhesives approved for the application of lippings (see section 9). Alternatively, lippings in accordance with details shown in section 5.3 may be used however, where pivots or bottom straps are required, the hardwood blocking detailed below must be installed.

Cross Section through Bottom of Flamebreak 660 Ply Faced fitted onto Floor Spring and Pivot

Hardwood blocking insert or use thicker lipping (up to max. thickness specified in section 5.3)

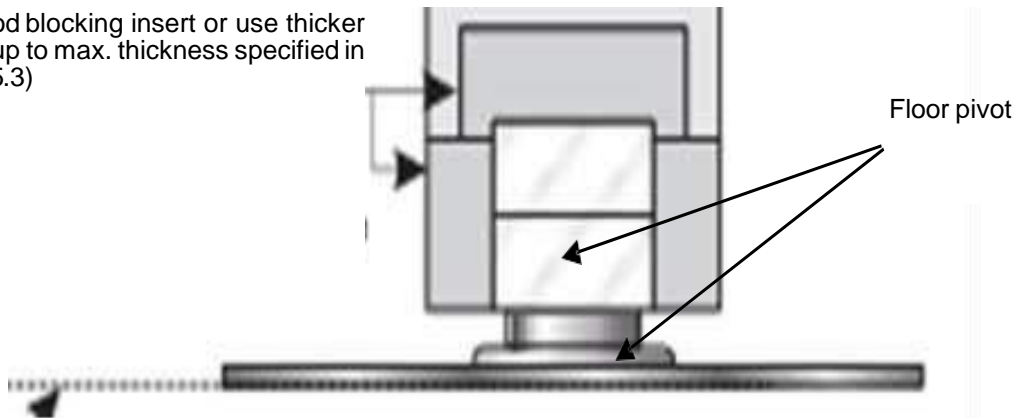

5.3.2 Meeting Stile Astragals – Flamebreak 660 Ply Faced only

Generally, fire doors should be able to open simultaneously. However, where additional performances are required (e.g., acoustic performances) it may be necessary to provide for sequential opening.

The astragal detail may be used where these conditions apply, without adverse influence on existing fire test/assessment data.

Astragals can be applied to both door leaves and may be profiled for aesthetic effect providing they meet the minimum specification given below.

The timber for the astragal must be hardwood (excluding Beech (*Fagus sylvatica*)) of the same minimum density being used for the lipping material. See following diagram:

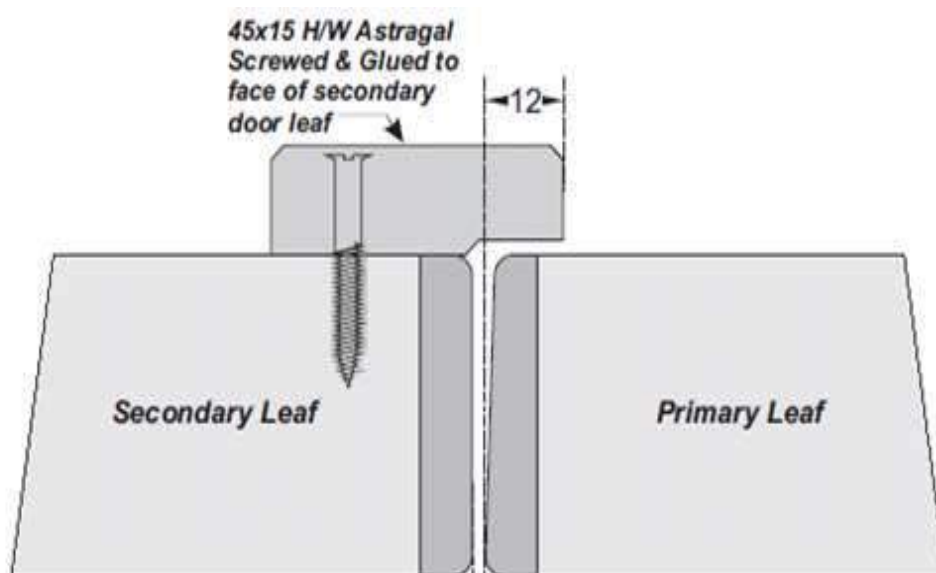

5.4 Edge Protectors

5.4.1 CS Group Edge Protectors

The Pacific Rim Wood Flamebreak 660 Ply faced design has been assessed for use with the CS Group edge protectors based on the supporting test evidence RF11061, IF11010B and IF13095 Revision A cited in section 3 and appendix C. CS Group edge protectors are supplied pre-formed with the approved intumescent material. The CS Group edge protectors must be used as part of a complete intumescent system and the required intumescent specification and leaf sizes are given in the relevant data sheets in section 4.5. CS Group must be contacted for precise installation and fixing details (www.c-sgroup.co.uk).

The Flamebreak 660 Ply faced design can be fitted with the CS Group edge protectors up to the maximum dimensions stated in the CS Group headed data sheets in section 4.5.

Based on the testing cited in section 3, the following limitations apply to locks/latches when using the CS Group Edge Protectors and takes precedence over the specification in section 10.4. The use of multipoint locks is not permitted.

Leaf options: Flamebreak 660 Ply Faced and FF660 MDF Faced

Configurations: LSASD, ULSASD, DASD, LSADD, ULSADD & DADD.

Lock/latches with the following specification are deemed acceptable.

Single and Double leaf doorsets

Element	Specification
Maximum forend and strike plate dimensions	155mm high x 25mm wide x 4mm thick
Maximum body dimensions	150mm high x 100mm wide x 18mm thick
Intumescent protection	see section 10.2
Materials	All parts essential to the locking/latching action (including the latch bolt, forend and strike) to be steel, stainless steel or brass with a melting point $\geq 800^{\circ}$ C

Notes:

1. In all instances the location of the handle must be between 800 – 1100mm from the threshold.

5.4.2 Yeoman Shield/Lorient PVCu Edge Protectors

The Pacific Rim Wood Flamebreak 660 Ply faced design has been assessed for use with the Yeoman Shield/Lorient PVCu edge protectors based on test RF07141 Rev B cited in section 3 and appendix C, and the following specification:

1. **Leaf options:** Flamebreak 660 Ply Faced and FF660 MDF Faced
2. **Configurations:** LSASD, ULSASD, DASD, LSADD, ULSADD & DADD
3. The Yeoman Shield/Lorient edge protectors must be used as part of a complete intumescent system and the required intumescent specification and leaf sizes are given in the relevant data sheets in section 4.5.
4. The Yeoman Shield/Lorient edge protectors must be fitted to vertical leaf edges only.
5. It is permitted to fit the edge protectors to one or both vertical leaf edges of a door leaf, subject to points below.
6. If Yeoman Shield/Lorient edge protectors are required at the meeting edges of double doorsets, they must be fitted to both meeting edges.
7. Timber lippings must be fitted, as per the specification given in section 5.3 above.
8. Lippings must be square, with no profiling permitted and containing no intumescent material.
9. The Yeoman Shield/Lorient edge protectors must be fixed with 50mm long No. 6- 8 steel wood screws, with a fixing no more than 150mm from the top and bottom of the edge protector and at maximum 200mm centres in between.
10. The PVC elements must be adhered to the door leaf using PVA adhesive.
11. Single point latches and flush bolts meeting the specifications in sections 10.4.1 and 10.8 respectively may be installed in the Yeoman Shield/Lorient PVCu edge protectors. 1mm thick Lorient MAP gaskets must be installed under forend & keep and lining all sides of the mortice for single and double leaf doorsets and encasing the entire body of the flush bolt including the back surface of the face plate.
12. Multipoint lock/latches are not permitted.

The Flamebreak 660 Ply faced design can be fitted with the Yeoman Shield/Lorient edge protectors up to the maximum dimensions stated in the Yeoman Shield/Lorient headed data sheets in section 4.5, permitted leaf dimensions have been assessed based on a comparison between the integrity performance observed in RF07141 Rev B and RF02054 which incorporated the same Lorient Type 617 seals in leaves which did not have the edge protectors installed.

5.5 Decorative & Protective Facings – Flamebreak 660 Ply Faced and FF660 MDF Faced

Relatively thin leaf facing materials are deemed to be decorative and their application is not considered to be of detriment to the overall stability or performance of the doorset design. In fact, when applied as an additional component on top of the minimum facing material required by the door blank, they are likely to provide a small enhancement in performance as an additional barrier to fire spread, although, this is likely to be negligible.

The following additional facing materials are therefore permitted for this door design since they would have limited influence under fire resistance test conditions.

Decorative & Protective Facing Specification	
Facing Material	Maximum Permitted Thickness (mm)
Paint	0.2
Timber veneers	2
Plastic laminates	2
PVC	2
Cellulosic and non-metallic foils	0.4

Notes:

1. Metallic facings are not permitted except for push plates and kick plates.
2. The door leaf thickness may be reduced on both sides by a maximum of 0.5mm for calibration purposes in order to accommodate the chosen finish. The minimum overall leaf thickness must remain at 54mm after finishing has been applied.
3. Materials must not return around leaf edges.
4. Materials must not conceal intumescent strips.
5. Decorative finishes listed above may be painted within the limits for paint finish, above.

5.5.1 Post-Formed CS Group Acrovyn

It is possible to encapsulate the Flamebreak 660 Ply faced doorset design by post-forming the Flamebreak 660 Ply faced door blanks in CS Group Acrovyn, based on the test evidence RF11061, IF11010B and IF13095 Revision A cited in section 3 and appendix C and the following specification:

1. CS Group Acrovyn must be wrapped around the vertical edges of the leaf only, i.e. the top and bottom of the leaf must remain exposed.
2. The vertical edge detail prior to post-forming must be lipped with 8mm thick hardwood as detailed in this assessment (see section 5.3).
3. The maximum radius of the lipping at the corners of the vertical edges before post-forming must be 9mm, which provides for 11mm external radius after the CS Group Acrovyn has been applied.
4. The intumescent detail as specified the relevant (CS Group headed) data sheets contained in section 4.5 of this assessment must be replicated.
5. CS Group Acrovyn must be bonded to the leaf using 3M Scotch-Grip cement 10 contact adhesive, or equivalent.
6. See relevant (CS Group headed) data sheets in section 4.5 of this assessment for maximum permitted leaf sizes.
7. The maximum thickness of CS Group Acrovyn used must be 2mm, as per test evidence.
8. The CS Group Acrovyn can be provided as pre-formed trays with dimensions to suit the proposed leaf sizes, as well as sheets for post-forming by the door manufacturer.

5.6 Decorative Planted on Timber Mouldings – both Leaf Options

Decorative mouldings can be applied to the door leaf facing providing the following criteria is adhered to.

1. Are surface applied to the door.
2. Are no higher than 30mm i.e. proud of the door.
3. Are no wider than 50mm.
4. Cover no more than 20% of the door leaf area.
5. Are no closer than 80mm to the door leaf edge.
6. The mouldings must be bonded in place using UF, PF, PVA, PVAC or PU glue.
7. Mechanical fixings may be used, 23 gauge headless nails are acceptable, at a minimum of 50mm from the ends of mouldings and at no less than 200mm centres.

6 Glazing within the Leaf

6.1 General

The testing conducted on the Flamebreak 660 Ply faced and FF660 MDF faced door designs has demonstrated that they are capable of tolerating glazed apertures, whilst providing a margin of over performance. For example, test reference RF02055 included a glazed aperture 600mm high x 600mm wide within a Flamebreak 660 Ply faced leaf and test reference WF503863 included a glazed aperture 452mm high x 202mm wide within a Flamebreak FF660 MDF faced leaf. Glazing is therefore acceptable within the following parameters.

The maximum assessed glazed area for all leaf configurations is 0.432m².

Maximum height and width of a glazed aperture is restricted to 720mm.

Glazed openings must not be less than 100mm from top and side edges and 250mm from the bottom edge.

Multiple apertures are acceptable within the permitted glazed area, with a minimum dimension of 80mm of core between apertures.

For all glass types and glazing system detailed herein:

- Aperture shape must be rectilinear unless alternative shape has been proven by test.
- Apertures cannot be rotated (e.g. a square to be rotated to create a diamond effect).

6.1.1 Single Pane Glass & Glazing Systems – Flamebreak 660 Ply Faced and FF660 MDF Faced

The glazing system must be one of the following proprietary tested systems.

The table below specifies the maximum assessed area of glazing for each permitted glass type and glazing system.

The numerical figures in the main body of the table are the maximum area of glass (in m²) that is considered acceptable for an individual glazed aperture, based upon the specific system.

The total area of all glazed apertures must not exceed that stated in Section 6.1 above.

	Glass type and manufacturer	Glazing system and manufacturer (m ²)									
		1.	2.	3.	5. Note 1	6.	7.	8.	9. Note 6	10. Note 7	11. Note 3
		Therm A Glaze 60 Intumescent Seals Ltd (CF284)	Fireglaze 60 Sealmaster UK Ltd	Pyroglaze 60 Mann McGowan Ltd	System 36-15 Plus Lorient Polyproducts Ltd (CF5060)	System 90+ Lorient Polyproducts Ltd (CF185)	System RF1 Lorient Polyproducts Ltd	FG60 Pyroplex Ltd	Vision 60 Norsound Ltd	Universal 60 Norsound Ltd	STS105GT3 /ST302 Sealed Tight Solutions Ltd ²
1.	Pyroshield 2 - Clear Pilkington UK Ltd ⁴	See note 5									
2.	Pyran S Schott Glass Ltd	0.43	0.43	0.43	na	0.43	0.43	0.43	0.43	0.43	na
3.	Pyrostem Pyroguard UK Ltd	0.43	0.43	0.43	na	0.43	0.43	0.43	0.43	0.43	na
4.	Pyroclear 60-001 Pilkington UK Ltd	See section 6.3									
5.	Pyrodur 60-10 Pilkington UK Ltd	0.43	0.43	0.43	na	0.43	0.43	0.43	0.43	0.43	na
6.	Pyrobelite 12 AGC Flat Glass UK	0.43	0.43	0.43	na	0.43	0.43	0.43	0.43	0.43	0.43
7.	Contraflam 60 Vetrotech St. Gobain	0.43	0.43	0.43	na	0.43	0.43	0.43	0.43	0.43	0.43
8.	Pyrostop 30-10 Pilkington UK Ltd	0.43	0.43	0.43	0.72	0.43	0.43	0.43	0.43	0.43	0.43
9.	Pyrobel 16 AGC Flat Glass UK ²	0.43	0.43	0.43	0.72	0.43	0.43	0.43	0.43	0.43	0.43
10.	Pyrostop 60-101 Pilkington UK Ltd	See section 6.4									
11.	Pyroguard 60-23 Pyroguard UK Ltd	See section 6.5									
12.	Pyrobel 25 AGC Flat Glass UK ²	See section 6.6									

Notes – see next page.

1. System 36-15 Plus must only be used with the 14 – 16mm thick glass types, i.e. glass types 8 & 9 from the table.
2. All glass types must be fitted fully in accordance with the manufacturers' tested details/installation requirements, particularly with respect to edge cover and expansion tolerances.
3. Glazing system 11 may only be used with glass types 6 – 9, see section 6.10 for additional scope.
4. Glass types 10 - 12 are fully insulating for 60 minutes in terms of the criteria set out in BS 476 Part 20:1987.
5. Pyroshield 2 is limited to 2No glazing systems; either Therm-a-Glaze 60 at a maximum height of 1300mm and maximum width of 550mm up to a total area of 0.43m², or System 90+ at a maximum height of 1300mm and maximum width of 310mm wide up to a maximum area of 0. 4m².
6. See section 6.8 below for additional scope.
7. See section 6.9 below for additional scope.

6.2 Glazing Beads & Installation – all Leaf Options

The 3D models in the following sections are provided as a generalised illustration of the glazing installation only; actual installation must be as per the specific details noted within this document.

6.2.1 Chamfered Bead

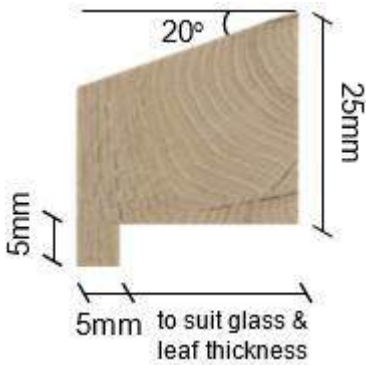
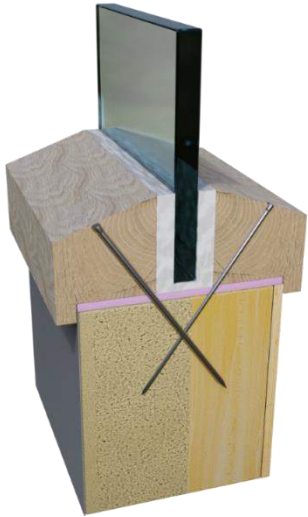
Permitted with glazing system 1, 2 & 3 from the table in Section 6.1.1	
	
<ul style="list-style-type: none"> • The glazing beads must be created from hardwood (not Beech <i>fagus species</i>) of a minimum 640kg/m³ density. • Glazing beads must be retained in position with 60mm long steel pins or 60mm long No. 6-8 screws, inserted at 35-40° to the vertical. • Fixings must be at 150mm maximum centres and no more than 50mm from each corner. Pneumatically fired pins are acceptable providing the pins meet the specification given in section 6.11 below. • The fitting of the glazing seal between the bead and the glass should generally be in accordance with the manufacturer's instructions with a tight fit present between the substrates. • Glass should be aligned within the aperture using hardwood or non-combustible setting blocks placed at the bottom horizontal edge only, sized to provide edge cover and expansion allowance as the specific system requires 	

Permitted with glazing system 4 from the table in Section 6.1.1

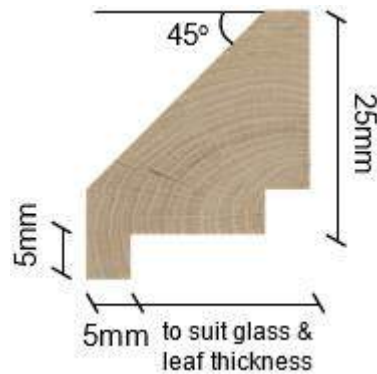

- The glazing beads must be created from hardwood (not Beech *fagus species*) of a minimum 640kg/m³ density.
- Glazing beads must be retained in position with 60mm long steel pins or 60mm long No. 6-8 screws, inserted at 35-40° to the vertical.
- Fixings must be at 150mm maximum centres and no more than 50mm from each corner. Pneumatically fired pins are acceptable providing the pins meet the specification given in section 6.11 below.
- The fitting of the glazing seal between the bead and the glass should generally be in accordance with the manufacturer's instructions with a tight fit present between the substrates.
- Glass should be aligned within the aperture using hardwood or non-combustible setting blocks placed at the bottom horizontal edge only, sized to provide edge cover and expansion allowance as the specific system requires

Permitted with glazing system 5 from the tables in Section 6.1.1

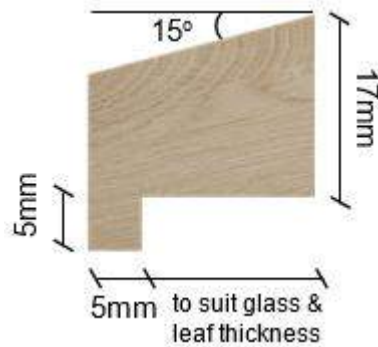

- The glazing beads must be created from hardwood (not Beech *fagus species*) of a minimum 640kg/m³ density.
- Glazing beads must be retained in position with 60mm long steel pins or 60mm long No. 6-8 screws, inserted at 35-40° to the vertical.
- Fixings must be at 150mm maximum centres and no more than 50mm from each corner. Pneumatically fired pins are acceptable providing the pins meet the specification given in section 6.11 below.
- The fitting of the glazing seal between the bead and the glass should generally be in accordance with the manufacturer's instructions with a tight fit present between the substrates.
- Glass should be aligned within the aperture using hardwood or non-combustible setting blocks placed at the bottom horizontal edge only, sized to provide edge cover and expansion allowance as the specific system requires

Permitted with glazing system 6 from the table in Section 6.1.1

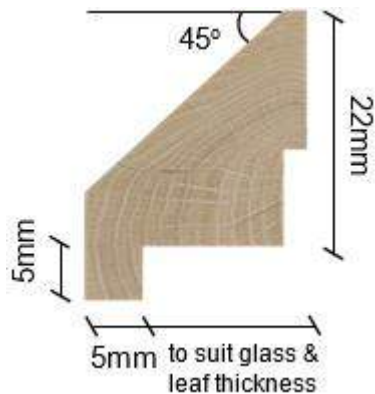

- The glazing beads must be created from hardwood (not Beech *fagus species*) of a minimum 640kg/m³ density.
- Glazing beads must be retained in position with 60mm long steel pins or 60mm long No. 6-8 screws, inserted at 35-40° to the vertical.
- Fixings must be at 150mm maximum centres and no more than 50mm from each corner. Pneumatically fired pins are acceptable providing the pins meet the specification given in section 6.11 below.
- The fitting of the glazing seal between the bead and the glass should generally be in accordance with the manufacturer's instructions with a tight fit present between the substrates.
- Glass should be aligned within the aperture using hardwood or non-combustible setting blocks placed at the bottom horizontal edge only, sized to provide edge cover and expansion allowance as the specific system requires

Permitted with glazing systems 7 & 8 from the tables in Section 6.1.1

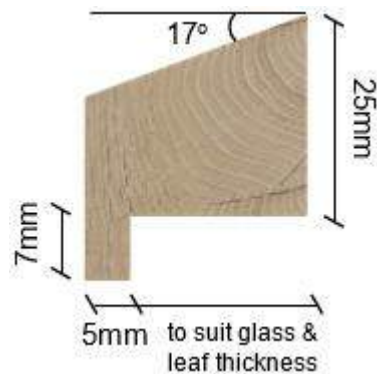

- The glazing beads must be created from hardwood (not Beech *fagus species*) of a minimum 640kg/m³ density.
- Glazing beads must be retained in position with 50mm long steel pins or 60mm long No. 6-8 screws, inserted at 35-40° to the vertical.
- Fixings must be at 150mm maximum centres and no more than 50mm from each corner. Pneumatically fired pins are acceptable providing the pins meet the specification given in section 6.11 below.
- The fitting of the glazing seal between the bead and the glass should generally be in accordance with the manufacturer's instructions with a tight fit present between the substrates.
- Glass should be aligned within the aperture using hardwood or non-combustible setting blocks placed at the bottom horizontal edge only, sized to provide edge cover and expansion allowance as the specific system requires

6.2.2 Square Beads

Permitted with glass types 5 - 9 from the table in section 6.1.1 only and may only be used with glazing systems 1 & 2 listed in the table



- The glazing beads must be created from hardwood (not Beech *fagus species*) of a minimum 640kg/m³ density.
- Glazing beads must be retained in position with 60mm long steel pins or 60mm long No. 6-8 screws, inserted at 35-40° to the vertical.
- Fixings must be at 150mm maximum centres and no more than 50mm from each corner. Pneumatically fired pins are acceptable providing the pins meet the specification given in section 6.11 below.
- A 6 – 10mm thick square aperture liner is permitted for use with square beads providing it is constructed from hardwood (not Beech *fagus species*) of minimum density 640kg/m³ and glued in position using a UF, PVA or PU type adhesive.
- The fitting of the glazing seal between the bead and the glass should generally be in accordance with the manufacturer's instructions with a tight fit present between the substrates.
- Glass should be aligned within the aperture using hardwood or non-combustible setting blocks placed at the bottom horizontal edge only, sized to provide edge cover and expansion allowance as the specific system requires

6.3 Pyroclear 60-001 (6mm thick) – Pilkington Group Ltd

The following limitations will apply to Pilkington Pyroclear 60-001 glass type tested in RF12077:

1. Hardwood (min. density 640kg/m³) excluding Beech (*Fagus sylvatica*) glazing beads 25mm high x 25mm deep including a 5mm x 5mm bolection return and a 20° chamfer.
2. Beads must be retained in position with 50mm long x 2mm diameter steel pins or 50mm long No. 6 – 8 steel screws, inserted at 45° to the vertical, at no more than 50mm from each corner and at 150mm maximum centres. Pneumatically fired pins are acceptable providing the pins meet the specification given in section 6.11 below.
3. 20mm x 5mm Kerafix Flexit seal compressed to 4mm and fitted between the bead and the glass on both faces.
4. 54mm x 2mm Palusol ELSA 1000 glazing liner must be fitted lining the full width of the glazing aperture.
5. 10mm x 2mm Interdens must be fitted on top of the Palusol glazing liner, underneath the edge of the glass in between the beads.
6. The glass must be fitted with maximum 12mm edge cover and allowing for 8mm expansion on all edges.
7. Timber for glazing beads must be hardwood (excluding Beech (*Fagus sylvatica*)),
8. Glazed openings must not be less than 100mm from any edge, with a minimum dimension of 100mm between apertures.
9. Multiple apertures are permitted, subject to point 8 above.

6.4 Pyrostop 60-101 (23mm thick) – Pilkington Group Ltd

The following system must be used with the Pilkington 23mm Pyrostop glass type tested in RF05035:

1. Hardwood (min. density 640kg/m³) excluding Beech (*Fagus sylvatica*) glazing beads 20mm high x 17.5mm deep including a 5mm x 5mm bolection return.
2. Beads must be retained in position with 60mm long No. 6 – 8 steel screws, inserted at 30° to the vertical, at no more than 50mm from each corner and at 150mm maximum centres.
3. 20mm x 3mm Hodgsons Sealants Firestrip 60 fitted between the bead and the glass on both faces.
4. 50mm x 2mm Norseal flexible glazing liner must be fitted around the perimeter of the glazing aperture.
5. The glass must be fitted with maximum 5mm edge cover and allowing for 5mm expansion on all edges.
6. Timber for glazing beads must be hardwood (excluding Beech (*Fagus sylvatica*)),
7. Glazed openings must not be less than 100mm from any edge, with a minimum dimension of 100mm between apertures.
8. Multiple apertures are permitted, subject to point 7 above.

6.5 Pyroguard 60-23 (23mm thick) – Pyroguard UK Ltd

The following system must be used with the Pyroguard UK Ltd. 23mm Pyroguard glass type based on Certifire certificate No CF 437:

1. Hardwood (min. density 640kg/m³) excluding Beech (*Fagus sylvatica*) glazing beads 30mm high x 16mm deep including a 5mm x 5mm bolection return and a 20° chamfer.
2. Beads must be retained in position with 63mm long No. 6 – 8 steel screws, inserted at 40 – 45° to the vertical, at no more than 50mm from each corner and at 150mm maximum centres.
3. 25mm x 2.5mm Sealmaster Fireglaze tape (as glazing tape) fitted between the bead and the glass on both faces.
4. 54mm x 2.5mm Sealmaster Fireglaze tape (as aperture liner) must be fitted lining the glazing aperture.
5. The glass must be fitted with maximum 15mm edge cover and allowing for 5mm expansion on all edges.
6. Aperture shape is not restricted, providing the glazing system and beads are compatible with that shape.
7. Timber for glazing beads must be hardwood (excluding Beech (*Fagus sylvatica*)),
8. Glazed openings must not be less than 100mm from any edge, with a minimum dimension of 100mm between apertures.
9. Multiple apertures are permitted, subject to point 8 above.

6.6 Pyrobel 25 (25mm thick) – AGC Flat Glass Europe

The following system must be used with the AGC Flat Glass Europe 25mm Pyrobel glass type tested in RF05126:

1. Hardwood (min. density 640kg/m³) excluding Beech (*Fagus sylvatica*) glazing beads 30mm high x 17.5mm deep including a 5mm x 5mm bolection return and a 20° chamfer.
2. Beads must be retained in position with 60mm long No. 6 – 8 steel screws, inserted at 30° to the vertical, at no more than 50mm from each corner and at 150mm maximum centres.
3. 25mm x 2mm Superwool X607 fitted between the bead and glass on both faces.
4. 2mm thick Sealmaster GL60 intumescent liner around perimeter of glazing aperture.
5. The glass must be fitted with maximum 21mm edge cover and allowing for 4mm expansion on all edges.
6. Timber for glazing beads must be hardwood (excluding Beech (*Fagus sylvatica*)),
7. Glazed openings must not be less than 100mm from any edge, with a minimum dimension of 100mm between apertures.
8. Multiple apertures are permitted, subject to point 7 above.

6.7 Norsound – Norsound Vision 60B & 60T

The testing summarised with the Norsound Vision 60B & 60T glazing systems within Section 3 of this report has primarily been conducted utilising Pyroshield 2, which is a non-insulating glass with a relatively thin construction. It is the opinion of Warringtonfire that a glazing system tested with a thicker proven fire resisting glass would provide at least the same level of fire resistance if the glass were to be substituted for Pyroshield 2. Based on this judgment the above glass types 2, 3, 5, 6, 7, 8 & 9 in section 6.1.1 have been positively appraised for use within this Scope of Application.

The Norsound Vision 60B is illustrated below:

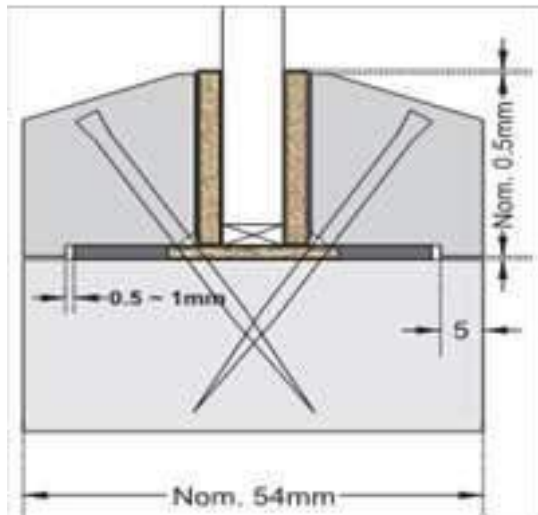

NOTE 1: * = 2mm Splay applies to all bead profile types.

Norsound Vision 60B Flush Bead Types

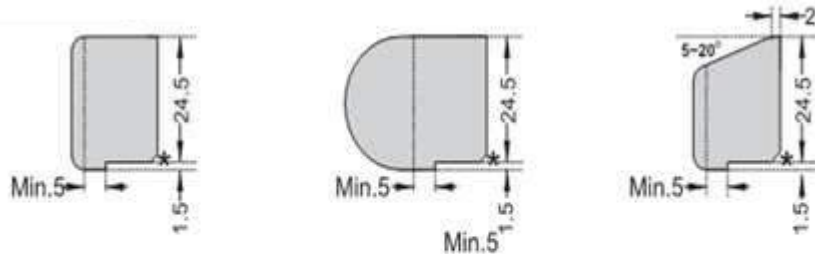

Norsound Vision 60B Belection Bead Types

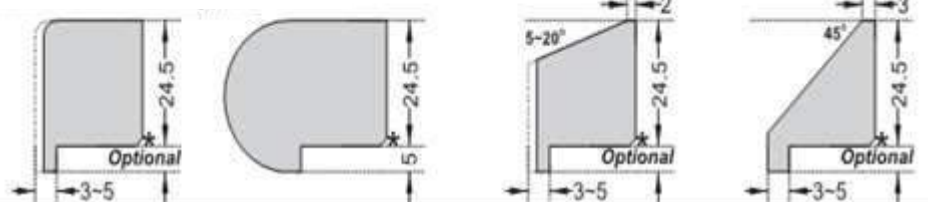

The Norsound Vision 60T is illustrated below:

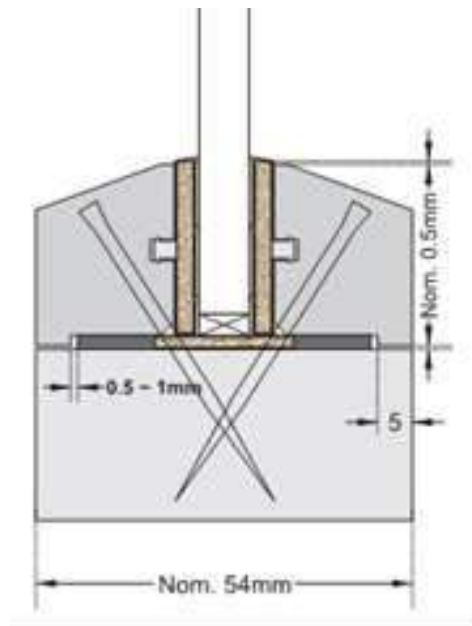

Norsound Vision 60T Flush Bead Types

NOTE 1: * = 2mm Splay applies to all bead profile types.

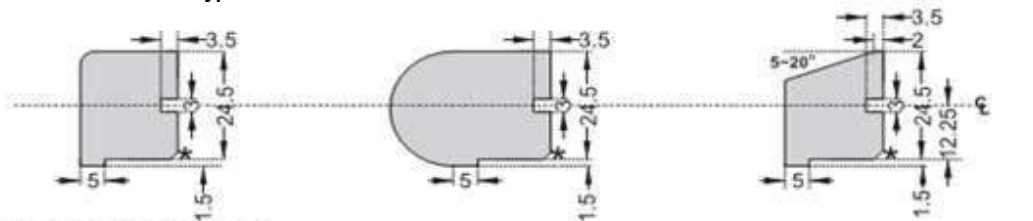

Norsound Vision 60T Bolection Bead Types

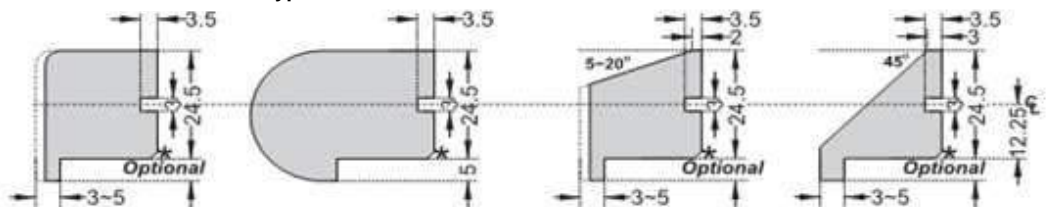

1. For flush style beads, the bead height must be nominally 26mm with a minimum rebate of 1.5mm. For bolection style beads, the bolection returns must be a minimum of 5mm high and project a minimum of 3mm from the leaf face.
2. The intumescent seal component of Norsound Vision 60B is 25mm high and is required to project 0.5mm above the sightline of the bead.
3. Glazing aperture must be lined with the Norsound 5202LNR liner which is supplied at 52mm wide and may be reduced to a minimum of 42mm wide – liner must be fitted centrally in the glazed aperture.
4. Glazing beads must be retained in position with minimum 50mm long x 2mm diameter steel pins, or 50mm long No. 6 – 8 screws, inserted at 35 – 40° to the vertical at no more than 50mm from each corner and at 150mm maximum centres.
5. Pneumatically fired pins are acceptable providing the pins meet the specification given in section 6.11 below.

The bead type and permitted glass types must meet the following specification:

Bead Type	Material	Min. Density (kg/m ³)	Permitted Glass Types
Square flush	Hardwood (excluding Beech (<i>Fagus sylvatica</i>))	640	1 – 3 (see section 6.1.1)
Bolection	Hardwood (excluding Beech (<i>Fagus sylvatica</i>))	640	1 – 9 excluding 4 (see section 6.1.1)

6.8 Norsound Ltd – Norsound Vision 60 Slimline

The testing summarised with the Norsound Vision 60B & 60T glazing systems within Section 3 of this report has primarily been conducted utilising Pyroshield 2, which is a non-insulating glass with a relatively thin construction. It is the opinion of Warringtonfire that a glazing system tested with a thicker proven fire resisting glass would provide at least the same level of fire resistance if the glass were to be substituted for Pyroshield 2. Based on this judgment the above glass types 2, 3, 5, 6, 7, 8 & 9 in section 6.1.1 have been positively appraised for use within this Scope of Application.

The following bead designs are assessed as acceptable for 60 minutes fire resistance, based upon the testing as summarised within Section 3.

NOTE 1: * = 2mm Splay applies to all bead profile types.

Typical Flush Bead Types:

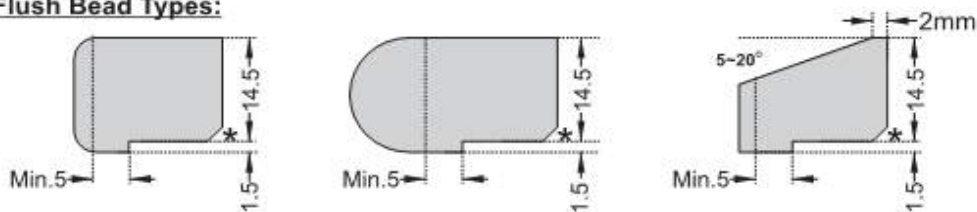

Typical Bolection Bead Types:

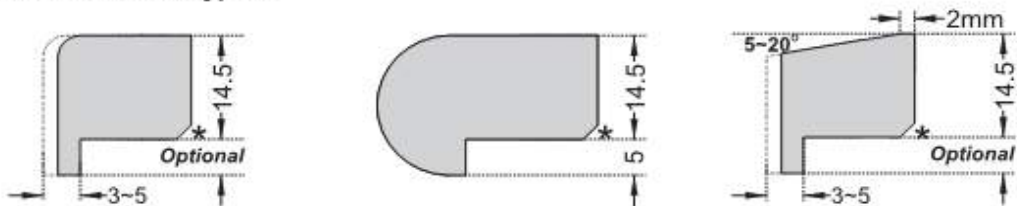

Norseal Vision 60T Slimline may utilise the same range of bead shapes.

Typical Flush Bead Types:

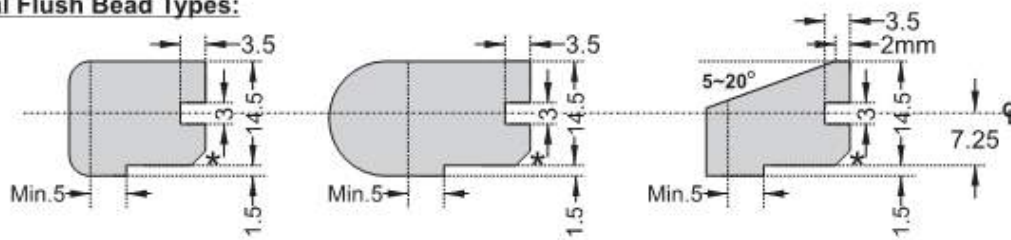

Typical Bolection Bead Types:

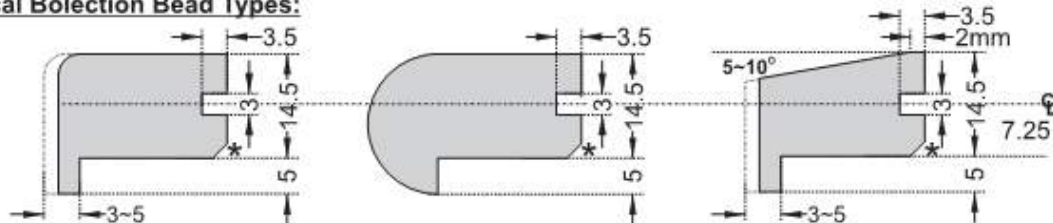

Notes:

1. Bead height must be nominally 14.5mm
2. The intumescent seal component of Norseal Vision 60B Slimline is 15mm high and is required to project 0.5mm above the sightline of the bead.
3. Glazing aperture must be lined with the Norseal 5202LNR; liner is supplied at 52mm wide and may be reduced to a minimum of 42mm wide – liner must be fitted centrally in the glazed aperture.
4. Bolection returns should be a minimum of 5mm high, and a minimum of 3mm thick (projecting from the leaf face)
5. The use of Beech (Fagus species) is not permitted for 60 minute applications.
6. Glazing beads must be retained in position with, minimum, 50mm long x 2mm diameter steel pins or, minimum, 50mm long No 6-8 screws, inserted at 35-40° to the vertical at no more than 50mm from each corner and at 150mm maximum centres.
7. Pneumatically fired pins are acceptable providing the pins meet the specification given in section 6.11.

6.9 Norsound Ltd. – Norsound Universal 60B & 60T

The Norsound Ltd. Universal glazing system has the following scope of application.

The Norsound Universal 60B is illustrated below:

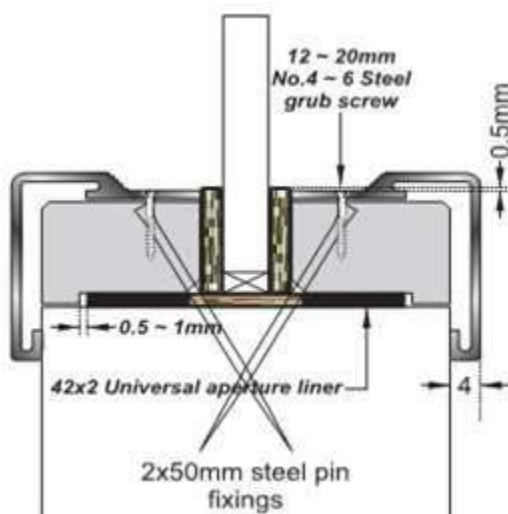

The Norsound Ltd. Universal 60T glazing system has the following scope of application. The Norsound Universal 60T is illustrated below:

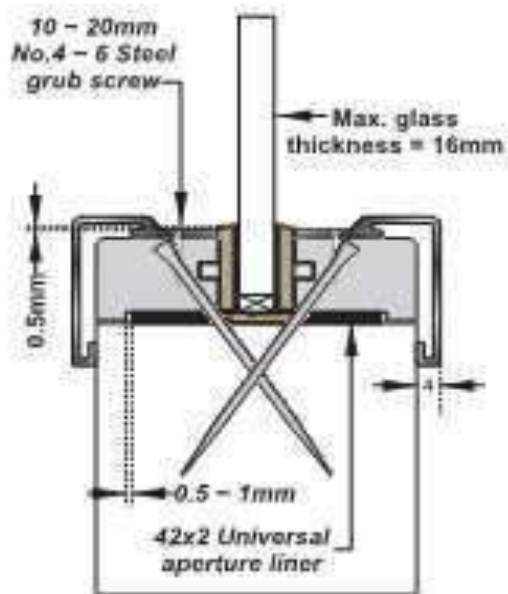

1. The core bead height must be nominally 14.5mm wide with a 1.5mm rebate.
2. The intumescent seal component of Norsound Universal 60B and 60T is 15mm high and is required to project 0.5mm above the sightline of the bead.
3. Glazing aperture must be lined with the Norsound 5202LNR liner which is supplied at 52mm wide and may be reduced to a minimum of 42mm wide – liner must be fitted centrally in the glazed aperture.
4. The position of the groove in the rear of the bead is therefore critical for installation of Norsound Universal 60T.
5. Glazing beads must be retained in position with minimum 50mm long x 2mm diameter steel pins or, minimum 50mm long No. 6 – 8 screws, inserted at 35 – 40° to the vertical at no more than 40mm from each corner and at 150mm maximum centres.
6. Pneumatically fired pins are acceptable providing the pins meet the specification given in section 6.11 below.
7. The Norsound Universal aluminium section cladding the timber bead must be secured to the core bead by use of 3No. 10 – 12mm No. 4 grub screws per length.

The bead material must meet the following specification and can be used with glass types 1 – 3 and 5 – 9 listed in section 6.1.1.

Material	Min. Density (kg/m ³)
Hardwood (excluding Beech (<i>Fagus sylvatica</i>)),	640

6.10 Sealed Tight solutions Ltd - ST105GT and ST105GT(3)

The Sealed Tight solutions Ltd. (STS) glazing system assessed in CNA/F15058 Revision C has the following scope of application.

The STS ST105GT system is illustrated below.

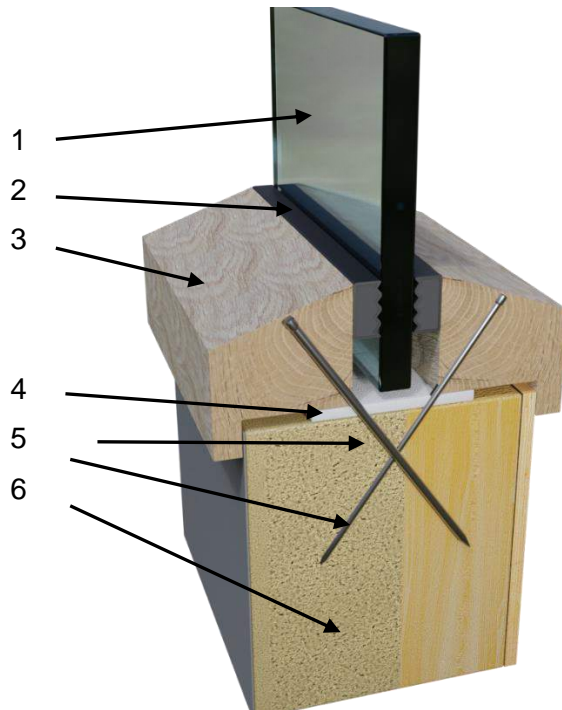

Key:

- (1) Assessed glass.
- (2) STS 10 x 3mm or 9 x 5mm 105GT(3) glazing tape fitted between the glass and beads on both faces.
- (3) Hardwood beading as detailed in section 6.10.1.1, fitted around the glazing apertures on both faces.
- (4) STS ST302 Glazing Liner
- (5) 50mm pins or screws
- (6) Door leaf

Notes:

1. The ST105GT and ST105GT(3) glazing systems may be freely interchanged.
2. Permitted with glass types 6 - 9 shown in the table in section 6.1.1.

6.10.1 60 Minute Glazing Beads & Installation Details for ST105GT and ST105GT(3)

6.10.1.1 Chamfered Beads for use with ST105GT and ST105GT(3)

Chamfered bead must be as specified below:

Chamfered Bead Specification			
Material	Application	Minimum Section Size (mm)	Minimum Density (kg/m ³)
Hardwood	Permitted for use with glass types 6 – 9 only, as specified in the table in section 6.1.1.	See diagrams below for minimum bead dimension for each permitted glass type and glazing system.	≥ 640

Notes:

1. Glazing beads must be hardwood timber.
2. The use of Beech (*Fagus species*) is NOT permitted.

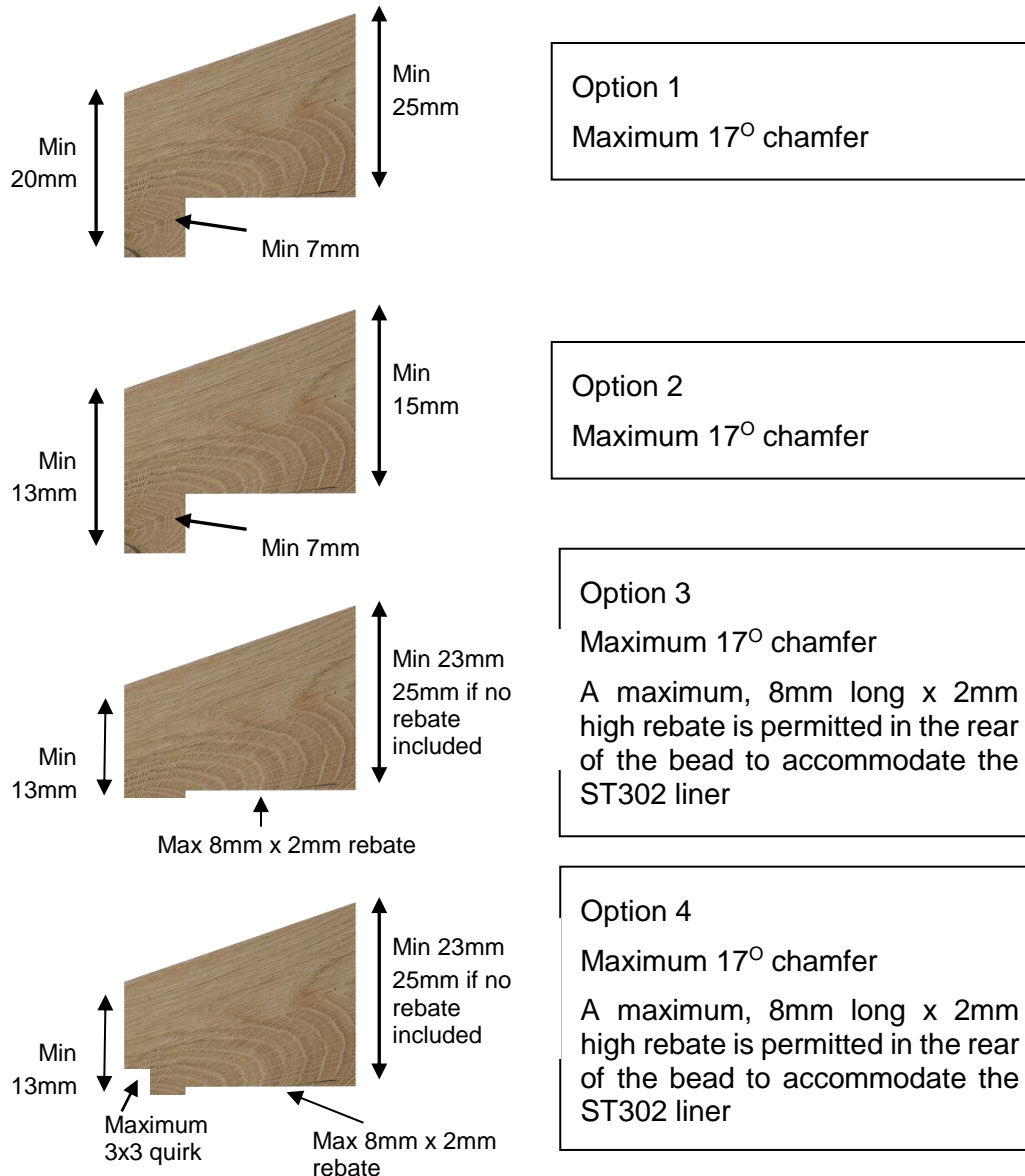

6.10.1.2 Square Beads for use with ST105GT and ST105GT(3)

Square bead must be as specified below:

Square Bead Specification			
Material	Application	Minimum Section Size (mm)	Minimum Density (kg/m ³)
Hardwood	Permitted for use with glass types 6 – 9 only, as specified in the table in section 6.1.1.	See diagram below.	≥ 640

Notes:

1. The minimum permitted dimensions for the bead are as shown in the diagrams below.
2. Bead options A & C may incorporate a rebate of maximum dimensions 8mm long x 2mm high as shown (as tested in FEP/F15035) to accommodate the ST302 liner. Where the rebate is included the 25mm high bead height dimension may include the 2mm high rebate.

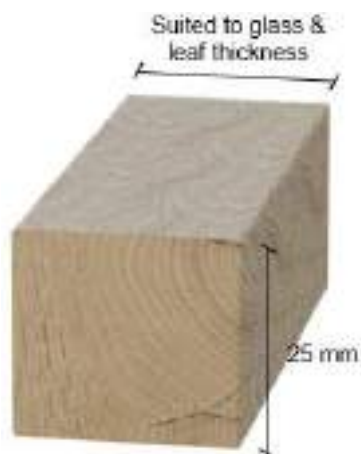

Option (A) Flush

Glazing installation as tested in FEP/F15035

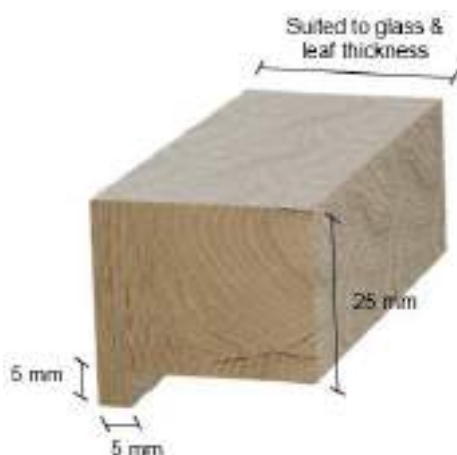
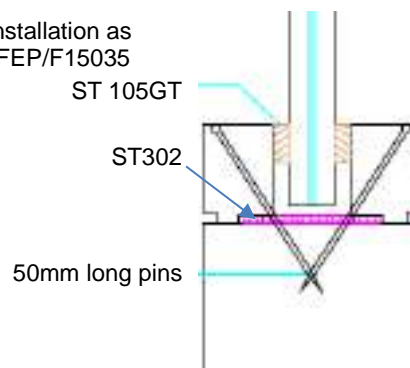

Option (B) with bolection



Option (C) with quirk

6.11 Glazing Pins for Glazing Within Leaf

The following pin specification is permitted and has been considered suitable for applications requiring a pin fixing to glazing beads:

Option 1 – Round, Oval & Rectangular Pins

The following dimension of pin has been approved for round, oval and rectangular shaped pins which are hand applied:

- Minimum Standard Wire Gauge (SWG) 16.
- Minimum cross section area of 2.03mm².
- Minimum linear dimension of 1.6mm in any direction, see figure below. The maximum pin diameter or any linear dimensions may be no greater than 2.0mm.



Option 2 – Gun (Pneumatically) Fired Rectangular Pins

The following dimension of rectangular pin has been deemed suitable for gun (pneumatically) fired applications.

- Minimum Standard Wire Gauge (SWG) 16.
- Minimum cross section area of 2.24mm².
- Minimum linear dimensions as shown in the figure.
- The 1.6mm dimension is predominately oriented perpendicular to the glass, where possible.
- The maximum pin diameter or any linear dimensions may be no greater than 2.0mm.

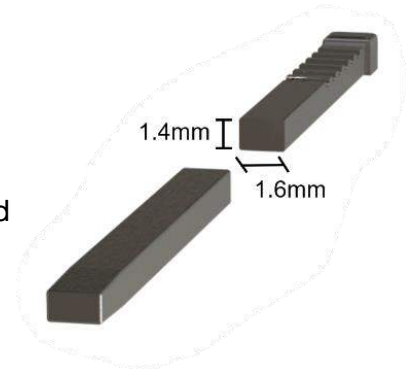

Pins with dimensions less than those stated above are not covered by this assessment.

7 Door Frame Construction

7.1 Frame Section Details

The door frames listed below are the minimum size and density which have been successfully tested and assessed by this report. The frame must be constructed to meet the following specification for single and double acting frames, where applicable.

Material	Minimum section size (mm)	Minimum density (kg/m ³)
Hardwood - the use of Beech (<i>Fagus species</i>) is NOT permitted.	Frame: 70 (d) x 32 (w) (excluding stop) Stop: 12 (w) (integral or planted on)	640

Note:

Minimum section size is subject to size of hardware and the use of transomed overpanel (see frame details below).

7.1.1 Standard frame detail

The diagram below shows detail of the standard frame construction. Minimum section is permitted in two sizes subject to hardware size and the use of transom overpanel.

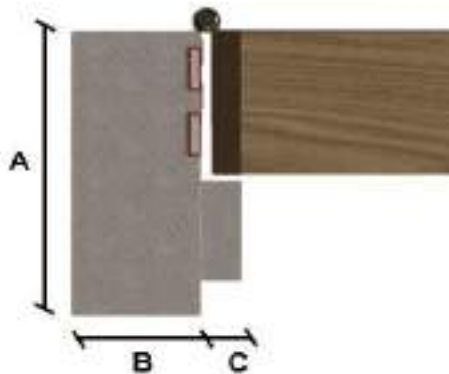

- A: Frame depth = 70mm minimum
- B: Frame width = 32mm minimum
- C: Stop width = 12mm minimum

Minimum section size when using a transom overpanel:

- A: Frame depth = 70mm minimum
- B: Frame width = 32mm minimum
- C: Stop width = 12mm minimum

7.1.2 Scalloped frame detail

The diagram below shows detail of the scalloped frame construction hanging edge only. When using scalloped frames for double acting doorsets, the groove for the specified intumescent strips must be as shown below and to the correct depth.

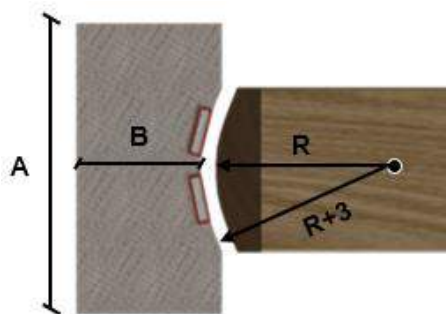

- A: Frame depth = 70mm minimum
- B: Frame width = 32mm minimum
- R: Radius from floor spring or pivot

7.1.3 Square frame detail for double acting doorsets

The diagram below shows detail of the square frame construction for the closing edge of a double acting doorset. Where utilising square frames for double acting doorsets, the maximum radius to the corners of the leaf is 8mm.

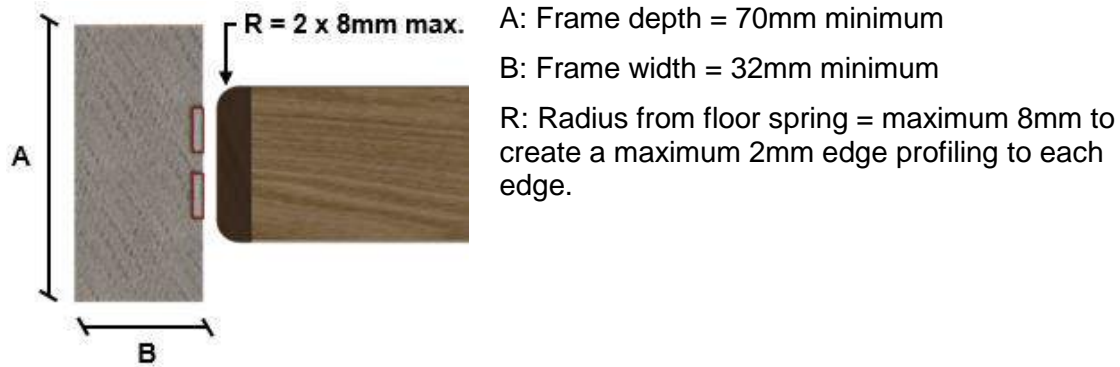

7.2 Threshold

Test reference WF408272 AR1 successfully evaluated the Exitex MXS/15-67 aluminium threshold plate protected with ST202 graphite liner fitted to the upper face of the plate, the aluminium threshold plate was mounted on top of a 90mm thick hardwood threshold. An STS ST422 drop seal was incorporated in the leaf threshold.

Where it is proposed to include the Exitex MXS/15-67 threshold plate, the ST422 dropseal and STS ST202 intumescent gasket must be installed as tested.

The use of a hardwood threshold beneath the MXS is optional.

7.3 Door Frame Joints

Below are depictions of the door framing joints that are deemed acceptable. Please note that the drawings are provided as general illustrations of each type of door frame joint; actual construction in terms of intumescent seal location and material, etc. must be as the text within this document specifies. The door frame joints are required to be tight, with no gaps, and require mechanical fixing with the appropriate size ring shank nails or screws. Frame joints may additionally be reinforced with any of the adhesives approved for the application of lippings, on the basis that the approved lipping adhesive has been proven to contribute to the positive fire resistance performance of the timber to timber junction at the door leaf edge.



Double Rebated Joint



Mitre Joint

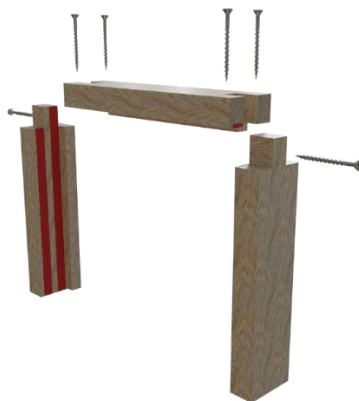

Mortice & Tenon Joint



Butt Joint



Trenched or Half Lapped Joint

8 Overpanels, Fanlights & Sidelights

8.1 Solid overpanels within Door Frame on all edges (transomed)

Overpanels of the same construction as the door leaves have been assessed as acceptable for use with doorsets constructed using the Flamebreak 660 Ply faced and FF660 MDF faced door blanks, providing they are separated from the leaf head(s) by a transom and fixed within a frame on all edges. This assessment is made on the basis of the performance of the door blanks when used as door leaves which have more freedom to deflect and distort in fire test conditions.

For solid panels constructed using the Flamebreak 660 Ply faced and FF660 MDF faced door blanks:

- Overpanels of the same construction as the door leaf/leaves may be used only when separated from the leaf/leaves by a transom. If the perimeter stiles and rails are still in position the panels do not need to be additionally lipped when used as an over panel. If framing has been removed for the purpose of constructing the overpanel, the panel must be lipped on the edge where the framing has been removed (if all framing has been removed the panel would need to be lipped on all edges). The overpanel must be fully contained within the door frame (see following diagram).
- A transom is required to separate the leaf head(s) from the overpanel and must be to the same specification as the door frame, as described in the table in section 7.1.
- Transom joints must utilise one of the following methods: mortice and tenon joints or butt joints (see section 7.3). Either method requires joints to be tight, with no gaps, and require mechanical fixing with the appropriate size ring shank nails or screws. Butt joints must be additionally bonded with urea formaldehyde.
- Joints are required to be tight, with no gaps, and require mechanical fixing with the appropriate size ring shank nails or screws.
- Solid overpanels must be fixed screwing through the rear of the frame with steel screws passing at least 30mm into the centre line of the overpanel. Fixings must be no more than 100mm from each corner and a maximum of 250mm centres in between.
- The frame to overpanel junction is permitted to have a maximum 1mm gap tolerance.



8.1.1 Fitted in square edge frame sections (i.e. no rebate)

The intumescent seals specified for the jambs in the relevant data sheet in section 4.5 must also be fitted to all four edges of the panel. The seals may be fitted either in the panel edges or alternatively in the frame reveal.

Maximum panel dimensions are given as below:

Assembly Element		Height (mm)	Width (mm)
Overpanel	Single Doorsets	2000	Overall doorset width
	Double Doorsets	1500	Overall doorset width

8.1.2 Fitted within rebated frame section

Solid overpanels fitted into rebated frame sections such that the panel butts up against the upstand of the rebate (the rebate can be created from solid or by the use of planted stop), must have intumescent seals as specified for the jambs in the relevant data sheet in section 4.5, fitted to all four edges of the panel. The seals may be fitted either in the panel edges or alternatively in the frame reveal.

Maximum panel dimensions are given as below:

Assembly Element		Height (mm)	Width (mm)
Overpanel	Single Doorsets	2000	Overall doorset width
	Double Doorsets	1500	Overall doorset width

8.2 Glazed Screens, Glazed Fanlights & Sidescreens

8.3 General

Based upon the available test evidence, referenced RF05036, there are 2No approved framing options that may be employed when fitting doorsets in glazed screens, which may be comprised of multiple glazed apertures as described below or comprise a glazed fanlight or sidescreen. These are described below. In both scenarios, the following limitations apply:

- Frame sections must be hardwood (not Beech (*Fagus species*)) minimum density 640kg/m³.
- The maximum height and width of the overall assembly is 2950mm.
- The centreline of the glass, where used, must be aligned with the centreline of the timber frame.
- The assembly may only contain either 1No single leaf door or 1No pair of doors.
- The assemblies may comprise multiple apertures with glass providing the total doorset and screen assembly does not exceed that noted above and the transom/mullion details in the following sections are complied with. Individual panels of glass must comply with the limitations noted in section 8.3.3.
- Joints must be tight with no gaps.
- Approved glass types are given in section 8.3.3.

8.3.1 Combination Frames

This method combines the door frame members with the side screen and fanlight frame members as illustrated in the example below:



Example of combination frame arrangement

When constructing a doorset assembly using combination frames the following limitations apply:

- The minimum frame section size (excluding integral/planted glazing beads or stop sections) must be 80mm deep x 44mm wide, for all frame sections.
- The common hanging jamb/screen mullion must run continuously full height of the door and overpanel/fanlight assembly.

8.3.2 Jointed Door Frames & Fanlights/Sidelights

This method combines the door frame members with the side screen and fanlight frame members as illustrated in the example below:



Example of jointed frame

When constructing a doorset assembly using the jointed framing system method, the following limitations apply:

- Separate sections of timber must be suitably fixed to one another using appropriate steel screw fixings and glued using one of the adhesives approved for the lipping in the adhesive section of this report.
- Screws must be fixed at maximum 600mm centres and penetrate to approximately 2/3rd depth of the adjacent timber section.
- The minimum overall frame section size at jointed frames (excluding integral/planted glazing beads or stop sections) must be 80mm deep x 64mm wide, created using equal width sections. See the relevant sections below for specific requirements in relation to integral/planted beads and stops.
- A framing section not abutting another may be reduced to a minimum frame section 80mm deep x 45mm wide (excluding integral/planted glazing beads or stop sections)
- 1No 15 x 4mm intumescent seal must be present rebated into the junction between the two frames, centrally fitted with respect to the depth.
- It is permitted to include maximum 3mm (w) x 3mm (d) quirks at the junction of each timber section.
- The drawings provided are representative of each type of common frame member; actual construction in terms of intumescent seal location and material, etc. must be as the text within this document specifies.

8.3.3 Approved Glass Types

The following section provides a scope of approval for the glass type tested in RF05036 when used in a glazed screen with doorset installed, using the framing options described in section 8.3.1 and 8.3.2 above.

Unless stated in the following section, all construction details for the doorset must remain as specified in the main assessment.

8.3.3.1 Pyrodur 60-10 (10mm thick) – Pilkington Group Ltd

Transom/mullion details:

- Hardwood (minimum density 640kg/m³) excluding Beech (*Fagus species*). The timber sections (common frame jambs, perimeter framing mullions etc.) are to meet the minimum section requirements as stated in section 8.3.1 and 8.3.2 above, as appropriate.

Glazing details:

- 20mm high x 40mm deep hardwood beads (minimum density 640kg/m³) excluding Beech (*Fagus sylvatica*) with a 15° chamfer.
- 60mm long size 6 – 8 steel wood screws at maximum of 50mm from corners and 150mm centres inserted at 30-45° to the glass.
- 20mm x 3mm Hodgsons Sealant Firestrip 60 located between the glass and the beads.
- 3mm high x 6mm wide x 40mm long hardwood or non-combustible setting blocks fitted at 300mm centres along bottom edge of glass with 5mm expansion allowance to all edges.

Maximum single pane dimensions:

Screen Element	Height (mm)	Width (mm)
Fanlight	810	1670
Side screen	2057	956

- The pane dimensions given above represent the maximum permitted width against maximum permitted height. Panes with smaller dimensions are acceptable.
- The maximum dimensions for a pane of glass above a mullion is limited to 1000mm (h) x 956mm (w)

8.4 Norsound Vision Glazing Systems – Fanlights & Side Screens

8.4.1 General

Timber framed doorsets may include glazed fanlights and/or side screens when glazed using the Norsound Vision Glazing Systems, tested as cited in section 3.1, has been assessed as the basis for the following scope of application.

The glazing system and beads must meet the specification shown in sections 8.4.4 – 8.4.6.

The door frame and screen framing construction must comply with the specification shown in section 8.4.7.

The maximum assessed fanlight and side screen dimensions are detailed in the table below, subject to the following restriction:

The glass must be able to demonstrate adequate performance when tested as a window or screen in accordance with BS 476 Part 22:1987 or BS EN 1634-1, at the pane dimensions to be installed.

Screen Element	Configuration	Height (mm)	Width (mm)
Fanlight	Single & double doorsets	≤600	Overall door width
Side Screen	Single & double doorsets	Overall door height	≤600



Note: Drawing is representative of doorset construction only; actual construction must be as the text within this document specifies

8.4.2 Frame Sections – Norsound Vision Glazing Systems

The following drawings depict possible constructions of combination frames and jointed frame sections for screens and door frame jambs:

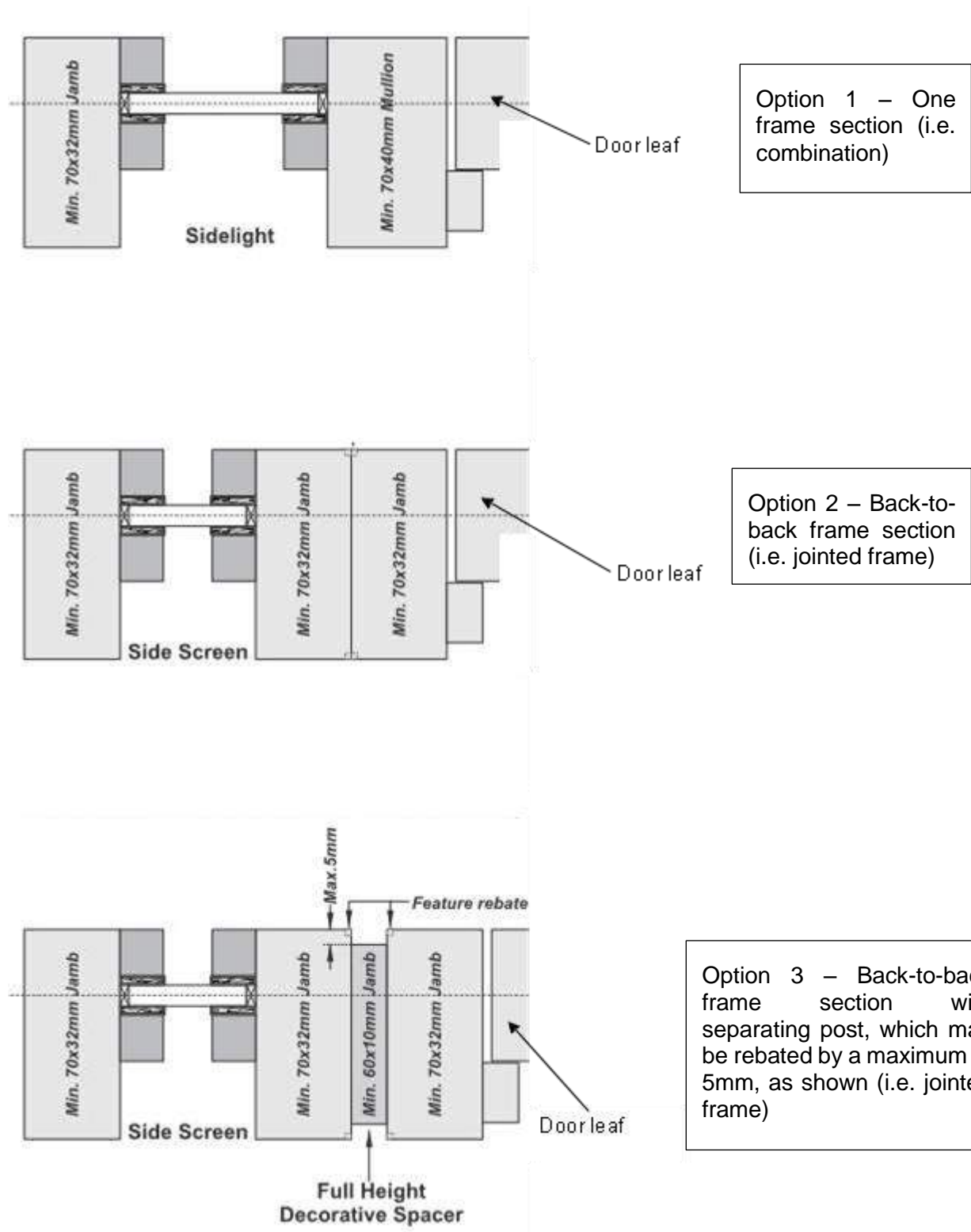

When using separate sections of timber, as shown above (options 2 and 3), each section must be suitably fixed to one-another using appropriate steel screw fixings and glued using Urea Formaldehyde. Screws must be fixed at 600mm centres and penetrate to approximately 2/3 depth of the adjacent timber section (including the entire depth of the spacer in option 3, if used). The overall frame section and material must match that given in this assessment for each glass type and glazing specification. Joints must be tight with no gaps.

It is permitted to include maximum 3mm (w) x 3mm (d) quirks/pencil rounds at the junction of each timber section for options 2 and 3.

Drawings are representative of each type of common frame section makeup; actual construction in terms of intumescent seal location and material, etc. must be as the text within this document specifies.

8.4.3 Screen elevations – Norsound Vision Glazing System

See sections 8.3.1 and 8.3.2 for illustrations of possible screen configurations when using combination frames and jointed door frames. When using the Norsound Vision glazing system the details below for construction and installation must take precedence over those above.

8.4.4 Glazing beads & Installation – Norsound Vision Glazing System

Glazing beads and intumescent materials must be installed in line with the following sections:

System Name		Norsound Vision 60B	Norsound Vision 60T
Typical Installation			
Dimensions	Bead height (mm)	Nominally 24.5	Nominally 14.5
	Intumescent Seals	25 high x 3 thick	15 high x 3 thick + 'plug'
Aperture Liner		Nominally – 2mm thick x minimum 42mm wide	

8.4.5 Norsound Vision 60B & 60T Applications

The following bead designs are assessed as acceptable when using the Norsound Vision 60B system, glass types 2, 3, 5, 6, 7, 8 & 9 in section 6.1.1 are acceptable:

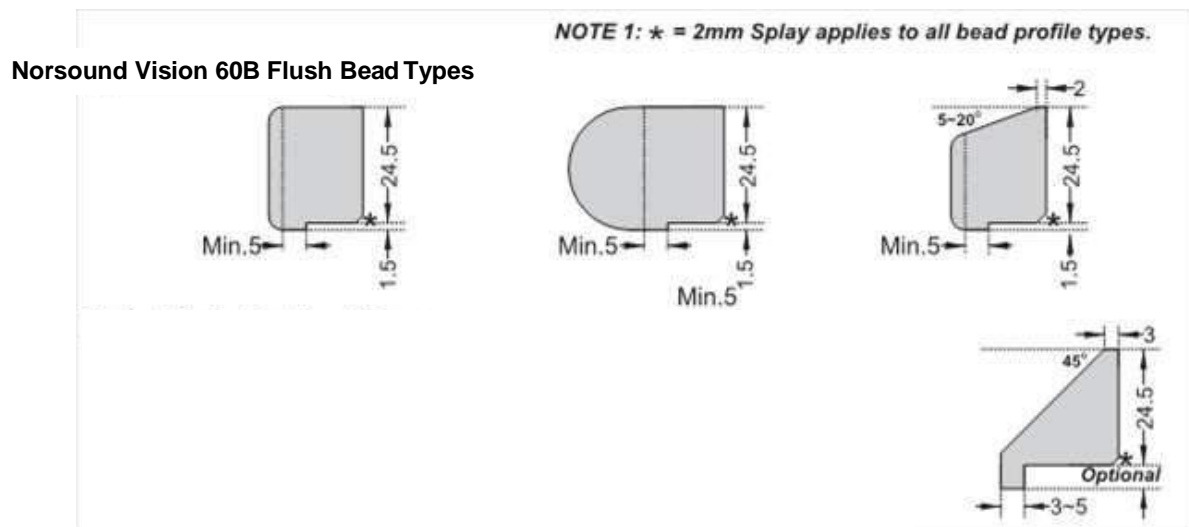

The following bead designs are assessed as acceptable for Norsound Vision 60T:

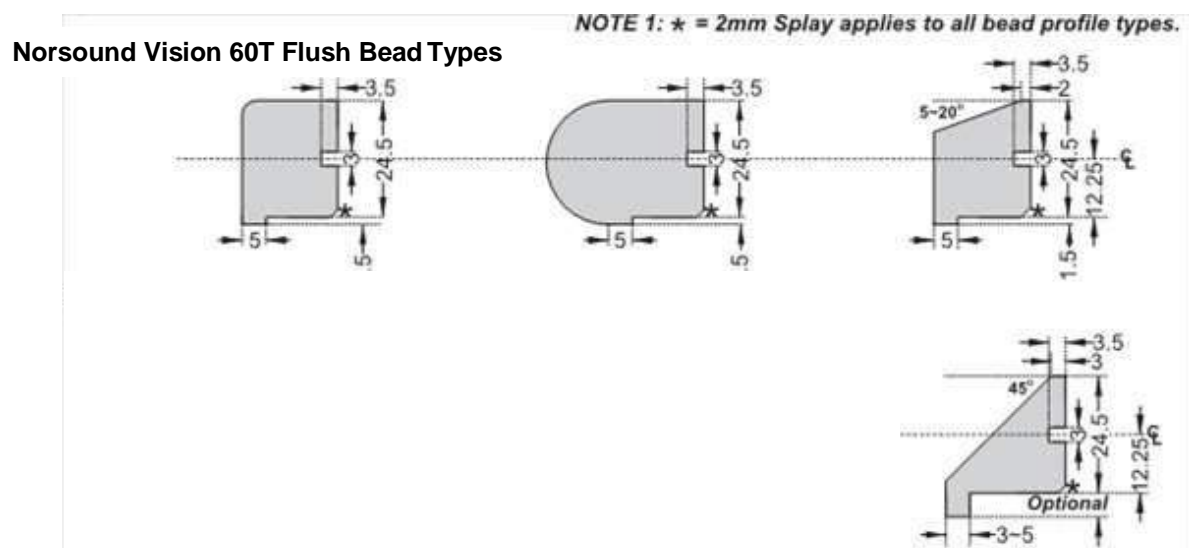

Notes:

1. Bead height must be nominally 24.5mm
2. The intumescent seal component of Norsound Vision 60B & 60T is 25mm high and is required to project 0.5mm above the sightline of the bead.
3. Glazing aperture must be lined with the Norsound 5202LNR liner which is supplied at 52mm wide and may be reduced to a minimum of 42mm wide – liner must be fitted centrally in line with the plane of the glass.
4. Glazing beads must be retained in position with minimum 50mm long x 2mm diameter steel pins, or minimum 50mm long No. 6 – 8 screws, inserted at 35 – 40° to the vertical, at no more than 50mm from each corner and at 150mm maximum centres.
5. Pneumatically fired pins are acceptable providing the pins meet the specification given above.

8.4.6 Glazing Bead Material – Norsound Vision Glazing System

All timber for glazing beads must be hardwood (excluding Beech (*Fagus sylvatica*)).

Integrity Performance	Bead Profile	Material	Min. Density (kg/m ³)
60	All in sections 8.4.4 & 8.4.5	Hardwood	640

8.4.7 Timber Screen Framing – Norsound Vision Glazing System

See sections 8.3.1 and 8.3.2 for illustrations of possible screen configurations when using combination frames and jointed door frames. When using the Norsound Vision glazing system the details below for construction and installation must take precedence over those above.

Element	Material	Min. Section Size (mm)	Min. Density (kg/m ³)
Perimeter screen framing	Hardwood	70 x 32	640
Mullions & transoms separating glass panes with side screens & fanlights	Hardwood	70 x 32	640
Back-to-back mullions separating side screens & doorsets (options 2 & 3 in section 8.4.2)	Hardwood	70 x 32	640
Transoms common to doorsets & fanlights	Hardwood	70 x 32	640
Mullions common to doorset jambs & side screens	Hardwood	70 x 40	640

Notes:

1. Timber for side screens must be constructed using hardwood (excluding Beech (*Fagus sylvatica*)).
2. The fanlight and side screens may comprise multiple panes of glass providing the total doorset and screen assembly does not exceed 2950mm high x 2950mm wide and the transom/mullion restrictions above are complied with.
3. Gaps between glass and framing to permit expansion should be set according to the glass manufacturer's information, using non-combustible or hardwood setting blocks at the bottom edge.

9 Adhesives

The following adhesives must be used in the construction of the doorsets. These may be hand applied or may be applied using an edge bander. With either method it must be ensured that sufficient glue is applied across the entire surface area between the 2No substrates being adhered to guarantee a robust bond. Other manufacturers' guidance should be followed, for either installation application used.

Element	Product/Material Type
Timber lipping	Urea formaldehyde, Resorcinol formaldehyde, Polyurethane ²
T-shaped Lippings	KoyoBond KR-560 + AP crosslinker
Decorative facings	UF, PUR or hotmelt EVA or PUR

Notes:

1. Flamebreak 660 Ply faced and FF660 MDF faced are proprietary products under the control of Pacific Rim Wood Ltd and manufactured by P.T. Kutai Timber of Indonesia. The adhesives for constructing the door blank are held in confidence (WF503863). The adhesives listed above are necessary for further fabrication of the door blanks into doorsets.
2. Polyurethane glue is only permitted for use on single leaf doorsets of the maximum dimensions specified in section 4.5. Glue line permitted based on RF08117 Revision A.

10 Hardware

10.1 General

The following section details the permitted scope and constraints for fitting hardware to this door design. The following items of hardware must also bear the UKCA or CE Mark in addition to the requirements outlined in the following sections. The UKCA or CE mark must indicate that the hardware is suitable for fire doors in the classification code and declaration of performance issued by the hardware manufacturer:

- Latches & locks: Test Standard EN 12209
- Single axis hinges: Test Standard EN 1935
- Controlled door closing devices: Test Standard EN 1154
- Electrically powered hold-open devices: Test Standard EN 1155
- Door co-ordinators: Test Standard EN 1158
- Emergency exit hardware: Test Standard EN 179
- Panic exit hardware: Test Standard EN 1125.

The following sections consider what tested and assessed alternative items of essential and non-essential hardware can be used on the doorset range.

Items of hardware have been considered and approved via the following means:

- The component has been successfully tested to BS 476 Part 22:1987 or BS EN 1634-1 in a suitably similar type of doorset e.g. timber leaf in timber frame.
- As a result of an assessment of the appropriateness of the item of hardware, based on test evidence not commissioned by Pacific Rim Wood Ltd
- As a result of the Certifire approval of the item of hardware.

Each section will consider the named item of hardware and detail if there are any limitations associated with:

- Leaf size
- Configuration
- Intumescent seals
- Intumescent protection
- Frame configuration requirements.

No item of hardware should be within 200mm of another item of hardware unless there is test evidence to demonstrate they can be in closer proximity.

Hardware items should generally be fitted in accordance with the manufacturer's instructions. **However, the parameters and requirements of this assessment always take precedence, including specified protection such as hardware gaskets.** Referenced Certifire approved hardware may be incorporated subject to the design, material and dimensional limitations identified within this assessment report and identified on the relevant Certifire certificate.

10.2 Intumescent to Hardware

The intumescent materials used to protect hardware that have been tested and assessed for this doorset design are detailed below. Note that any one of the product/matrix options listed in the table may be used in the specific application noted. However, only 1 No manufacturer should be considered per doorset application.

The door perimeter intumescent seal specifications are documented in conjunction with the leaf envelope size limitations in section 4.5.

Item	Location	Product/Manufacturer
Hinges	Under both hinge blades	1mm Interdens – Dufaylite Developments Ltd. 1mm Therm-A-Strip – Intumescent Seals Ltd. 1mm G30 – Sealmaster Ltd. 1mm Graphite – Sealed Tight Solutions 1mm NOR910 – Norsound Ltd.
Lock/latches	Single Point Engagement: Under forend & keep and lining all sides of the mortice (single and double leaf doorsets)	1mm Interdens – Dufaylite Developments Ltd. 1mm Therm-A-Strip – Intumescent Seals Ltd. 1mm G30 – Sealmaster Ltd. 1mm Graphite – Sealed Tight Solutions 1mm NOR910 – Norsound Ltd. ¹
	Multi Point Engagement	See section 10.4.2 for details
Top pivots & & bottom straps	Fitted underneath the body footprint of top pivots and bottom straps	1mm Interdens – Dufaylite Developments Ltd. 1mm Therm-A-Strip – Intumescent Seals Ltd. 1mm G30 – Sealmaster Ltd. 1mm NOR910 – Norsound Ltd.
Flush bolts	Encasing the entire body of the flush bolt including the back surface of the face plate	2mm Interdens – Dufaylite Developments Ltd. 2mm Therm-A-Strip – Intumescent Seals Ltd. 2mm G30 – Sealmaster Ltd. 1mm Graphite – Sealed Tight Solutions 1mm NOR910 – Norsound Ltd.

Notes:

1. The maximum latch forend size for use with 1mm NOR910 is 155mm high by 25mm wide.



Example of hinge protection detail



Example of lock & latch protection detail

Gaskets must be fitted where required by supporting data, i.e. test evidence or Certifire certificates. If gaskets are not required by the supporting data but they are required within this Field of Application, the requirements of this Field of Application take precedence.

Where it is stated that intumescent is not required for a particular element of hardware, it is permitted to use up to 2mm thick MAP, Interdens or graphite-based gasket tested for the particular application [as appropriate for the hardware]. It is the opinion of Warringtonfire that the additional protection will not detract from the fire resistance performance under test conditions.

10.3 Essential Hardware

The following table details the essential hardware for the various doorset configurations that are referenced in this assessment.

Configuration	Hardware
LSASD	<ul style="list-style-type: none"> • Latch • Handle • Hinges • Self-closing device (closer)
ULSASD	<ul style="list-style-type: none"> • Hinges • Self-closing device (closer)
DASD	<ul style="list-style-type: none"> • Top pivot & bottom strap • Floor spring self-closing device (closer)
LSADD	<ul style="list-style-type: none"> • Latch • Handle • Hinges • Self-closing device (closer) • Flush bolt
ULSADD	<ul style="list-style-type: none"> • Hinges • Self-closing device (closer) • Flush bolt¹
DADD	<ul style="list-style-type: none"> • Top pivot & bottom strap • Floor spring self-closing device (closer)

Note:

1. Flush bolts (and other edge mounted hardware apart from hinges) are not permitted for doorsets that are fitted with perimeter intumescent seals spaced 5mm apart, see relevant data sheet in section 4.5 for intumescent specifications BS4 and ED1.

10.4 Latches & Locks

10.4.1 Single Point Engagement

These items are suitable in the following applications only:

Leaf options: Flamebreak 660 Ply Faced and FF660 MDF Faced

Configurations: All permitted in section 4.5.2.

The table below details the tested latches and locks that are approved.

Element	Manufacturer & Product Reference
Locks & latches	1. Zoo-Vier DIN sash lock ref: ZDL7255RSS (tested in WF503863 in Flamebreak FF660 MDF faced with stiles trimmed by 5mm) 2. IR mortice latch (tested in WF374929 in Flamebreak 660 Ply faced with stiles completely removed) 3. E*S tubular mortice latch

Alternatively, components with the following specification are also deemed acceptable.

Single leaf doorsets

Element	Specification
Maximum forend and strike plate dimensions	235mm high x 25mm wide x 4mm thick
Maximum body dimensions	165mm high x 100mm wide x 18mm thick
Intumescent protection	see section 10.2
Materials	All parts essential to the locking/latching action (including the latch bolt, forend and strike) to be steel, stainless steel or brass with a melting point $\geq 800^{\circ}$ C

Double leaf doorsets

Element	Specification
Maximum forend and strike plate dimensions	150mm high by 25mm wide by 4mm thick
Maximum body dimensions	80mm high by 100mm wide by 18mm thick
Intumescent protection	see section 10.2
Materials	All parts essential to the locking/latching action (including the latch bolt, forend and strike) to be steel, stainless steel or brass with a melting point $\geq 800^{\circ}$ C

Notes:

1. In all instances the location of the handle must be between 800 – 1200mm from the threshold.

10.4.2 Latches & Locks – Multi Point Engagement

These items are suitable in the following applications only, based on the results of test WF408272:

Leaf options: Flamebreak 660 Ply Faced only

Configurations: LSASD

The table below details the tested multi point latch that is approved.

Element	Manufacturer & Product Reference
Locks & latches	1. Winkhaus AV2-F

The tested Winkhaus 3pt Autofire multipoint lock may be utilised with the Flamebreak 660 Ply faced design only, the internal framing (stiles and rails) must remain in place to the full dimensions shown in section 5.1.1, the locks must be installed with the tested intumescent protection detailed below. All 3 locking points must be engaged when the leaf is in the closed position.

Element	Specification (mm)
Forend	1770 high by 20 wide
Centre Lock Keep	234 high x 24 wide
Top & Bottom Keeps	174 high x 24 wide
Top & Bottom Lock Bodies	113mm high by 42mm wide by 16mm thick
Lock Cylinder	A lock cylinder must always be installed
Intumescent protection	Encasing middle lock body – STS ‘ST60 kit’. Encasing top and bottom hook bodies – 110 x 30 x 1mm thick STS graphite gasket Under all lock keeps – 20 x 1mm thick STS graphite gasket Under Forend – STS ST10x2mm full length in the Eurogroove
Materials	All parts essential to the lock must remain as tested
Location	Centre lock nib to be installed between 950mm and 1100mm from the threshold
Maximum Leaf Size (mm)	See section 4.5.10
Configurations	Latched, single acting, single leaf only

Note:

1. When a multi-point latch is fitted, the leaf perimeter edge intumescent must meet the specification in section 4.5.10.
2. The centre, top and bottom keep plates must be the same as those tested, as supplied by the manufacturer.
3. The top end of the forend of the multi point latch must not finish closer than 70mm from the leaf top horizontal edge.
4. The bottom end of the forend of the multi point latch must not finish closer than 135mm from the leaf bottom horizontal edge.

10.4.3 Latches & Locks – Edge Protector Specification

The following specification of lockset is required when using edge protectors:

Element		Specification
Maximum forend and strike plate dimensions	CS Group	155mm high by 25mm wide by 4mm thick
	Yeoman	125mm high x 25mm wide x 4mm thick
Maximum body dimensions	CS Group	150mm high by 100mm wide by 18mm thick
	Yeoman	100mm high x 100mm wide x 20mm thick
Intumescent protection - Under latch forend and keep and fully encasing the entire latch body		1. 1mm thick MAP Lorient Polyproducts Ltd. 2. 2mm thick Therm-A-Line Intumescent Seals Ltd. 3. 2mm thick Therm-A-Flex Intumescent Seals Ltd. 4. 2mm thick Therm-A-Line Intumescent Seals Ltd. - additional 2 no. layers (6mm thick in total) to rear face of latch body
Materials		All parts essential to the locking/latching action (including the latch bolt, forend and strike) to be steel, stainless steel or brass with a melting point $\geq 800^{\circ}$ C

10.4.4 Cylinders

These items are suitable in the following applications only:

Leaf options: Flamebreak 660 Ply Faced and FF660 MDF Faced

Configurations: LSASD and LSADD

The table below details the tested cylinders that are approved.

Element	Manufacturer & Product Reference
Cylinder	<ul style="list-style-type: none"> UAP Kinetica 3 Euro cylinder (WF408272)

Alternatively, components with the following specification are also deemed acceptable.

- Where required for use with either single or multi point latches, the cylinder must be constructed of either brass or steel with a melting point in excess of 800° C.
- The cylinder must be compatible with the lock/latch.
- Cylinder dimensions may be up to 33mm high x 17mm wide at the maximum dimension and may be of euro profile or oval.
- Single and double cylinders, along with cylinder & turn are permitted.
- Door preparation for single cylinders shall penetrate only half the door thickness.
- Intumescent protection and tightness of fitting:
 - Due to the intumescent materials that must be fitted around the body of locks, maximum permitted clearance between leaf and cylinder is 3mm to each edge.

10.5 Handles

These items are suitable in the following applications only:

Leaf options: Flamebreak 660 Ply Faced and FF660 MDF Faced

Configurations: – All permitted in section 4.5.2

The table below details the tested handles that are approved.

Element	Manufacturer & Product Reference
Handles	<ul style="list-style-type: none">Fab & Fix 'Windsor' footprint 208 x 28mm wideZoo 'Radius' lever on rose – ref: SSS-ZCS2030SSUnion steel lever type – 54 diameter rose

Alternative handles are permitted providing they meet the specification given below:

- Steel, stainless steel, brass, aluminium or bronze are permitted.
- Surface fixings or through fixings are permitted. If through fixed there must be no more than 0.5mm clearance between the hole and the fixing.
- The hole through the leaf to facilitate the spindle must be no greater than 20mm diameter.

The handle design may be either lever on rose or lever on back plate up to the following maximum sizes:

- Lever on rose with a rose diameter up to 54mm.
- Lever on back plate with a back plate size up to 243mm high x 56mm wide
- Lever handle length 250mm

The handle must be compatible with the lock/latch, such that the closing action of the doorset is not impeded.

Alternative escutcheons are permitted providing they meet the specification given below:

- Steel, stainless steel, brass, aluminium or bronze are permitted.
- Surface fixings or through fixings are permitted. If through fixed there must be no more than 0.5mm clearance between the hole and the fixing.
- The escutcheon may be up to Ø52mm overall and up to 8mm thick.

10.6 Butt Hinges

These items are suitable in the following applications only:

Leaf options: Flamebreak 660 Ply Faced and FF660 MDF Faced

Configurations: LSASD, ULSASD, LSADD, ULSADD

The table below details the tested butt hinges that are approved.

Element	Manufacturer & Product Reference
Hinges	<ul style="list-style-type: none"> Zoo Hardware, size 101 high x 30 mm wide each blade Royde & Tucker ref: H102, size 100 high x 35 mm wide each blade Eurospec ref: HIN1433, size 100 high x 31 mm wide each blade

Alternatively, components with the following specification are also deemed acceptable.

Element	Specification
Blade height:	90 - 120mm
Blade width (excluding knuckle):	30 - 35mm
Blade thickness	2.5 - 4mm
Fixings:	Minimum of 4 No. 30mm long No. 8 or No.10 steel wood screws per blade
Materials:	Steel or stainless steel

In all instances, the hinges must have the following specification.

Element	Specification		
Hinge positions:	Top	100 –180mm from the head to top of hinge	
	If 3 hinges are required:	2 nd	Minimum 200mm from top hinge or centrally fitted between top and bottom hinge
		Bottom	150 - 250mm from the foot of leaf to bottom of hinge
		Top	100-180mm from the head to top of hinge
	If 4 hinges are required:	2 nd & 3 rd	Equispaced between top and bottom or 2 nd hinge 200mm from top hinge and 3 rd hinge equally spaced between 2 nd and bottom hinge
		Bottom	150 - 250mm from the foot of leaf to bottom of hinge
Intumescent protection:		See section 10.2	

Note:

Leaves less than 2400mm (h) must be hung on a minimum of 3 hinges. Leaves greater or equal 2400mm (h) must be hung on 4 hinges.

10.7 Doorset Self Closing

Doorset automatic self-closing can be provided by:

- Overhead face fixed closers
- Floor springs with top pivots and bottom straps.

Automatic doorset self-closing devices such as transom mounted, and offset pivots used with floor springs are not considered acceptable for use with the Flamebreak 660 Ply faced or FF660 MDF faced doorset ranges.

10.7.1 Overhead Face Fixed Closer

These items are suitable in the following applications only:

Leaf options: Flamebreak 660 Ply Faced and FF660 MDF Faced

Configurations: LSASD, ULSASD, LSADD, ULSADD

The table below details the tested overhead face-fixed closers that are approved.

Element	Manufacturer & Product Reference
Overhead face-fixed closers	<ul style="list-style-type: none">• Rutland TS3204• Dorma TS71• Dorma TS83V• Arrone AR1500• Briton 121CE• Record DFA127²

Alternatively, components with the following specification are also deemed acceptable.

- Certifire approved overhead face-fixed closers for 60-minute fire resistance applications on 54mm thick timber door and timber frames.

Notes:

1. It must be ensured that the closer is of sufficient strength and power to ensure the door leaf/leaves fully engage into the frame reveal.
2. Where the Record DFA127 is specified, the closer body must be fixed to the door frame head – it is not permitted to fit the closer body to the leaf face. The frame head section must be a minimum of 35mm thick excluding any stop, the stop must be a minimum of 20mm high and may be integral or planted on. The door frame jambs may be to the same specification in section 7.1 which may result in differing frame element dimensions at the head and jambs.

10.7.2 Floor Spring Self Closing Device

These items are suitable in the following applications only:

Leaf options: Flamebreak 660 Ply Faced only

Configurations: DASD, DADD

Components with the following specification are deemed acceptable.

- Certifire approved floor spring self-closers for 60-minute fire resistance applications on 54mm thick timber door and timber frames.

Note:

For intumescent protection requirements, see section 10.2.

10.8 Flush Bolts

These items are suitable in the following applications only:

Leaf options: Flamebreak 660 Ply Faced only

Configurations: LSADD

Flush bolts may be incorporated centrally into the top and bottom of one meeting edge, providing the following maximum dimensions are not exceeded and the components are fitted opposite the edge fitted with intumescent strips:

- 203mm long x 20mm deep x 20mm wide.

Flush bolts must be steel, and the mortice must be as tight to the mechanism as is compatible with its operation. All edges of the mortice of the keep and body must be protected with intumescent gaskets as specified in section 10.2. Alternatively, the hardware manufacturers tested gaskets may be used. See note under the table in section 10.3.



Flush bolt installation and intumescent protection

10.9 Non-Essential Hardware

10.9.1 Pull Handles

These items are suitable in the following applications only:

Leaf options: Flamebreak 660 Ply Faced and FF660 MDF Faced

Configurations: DASD, DADD

Steel, stainless steel or bronze handles may be surface-fixed or bolted through the door leaf, providing the length is limited to 1200mm between the fixing points. If through fixed, there must be no more than 1mm clearance between the hole and stud.

The above scope of application is provided as in the opinion of Warringtonfire they will not significantly affect the fire resistance performance of the doorset being considered. This is on the basis of the items being surface mounted away from the edge of the door leaf, therefore unlikely to influence the junction between door leaf and frame. Furthermore, they are generally of lightweight construction, meaning that they are unlikely to destabilise the doorset and therefore cause adverse deflection under test conditions. Lastly, the surface mounted arrangement of the features means no material is removed in terms of the overall thickness of the door leaf beyond the footprint of the item, therefore burn through of the leaf would not be expected.

10.9.2 Push Plates & Kick Plates

Leaf options: Flamebreak 660 Ply Faced and FF660 MDF Faced

Configurations: All configurations

Push plates and kick plates with the following specification are deemed acceptable as in the opinion of Warringtonfire they will not significantly affect the fire resistance performance of the doorset being considered. This is on the basis of the items being surface mounted away from the edge of the door leaf, therefore unlikely to influence the junction between door leaf and frame. Furthermore, they are generally of lightweight construction, meaning that they are unlikely to destabilise the doorset and therefore cause adverse deflection under test conditions. Lastly, the surface mounted arrangement of the features means no material is removed in terms of the overall thickness of the door leaf beyond the footprint of the item, therefore burn through of the leaf would not be expected.

Approved specification:

- Polymeric or metal (excluding aluminium) face-fixed hardware such as push plates and kick plates up to 2mm thick may be surface fitted to the doorset. These items of hardware are permitted up to a maximum of 20% of the door leaf area if mechanically fixed and a maximum of 30% if bonded with a contact or other thermally softening adhesive. Plates must not return around the door edges or 'notch out'/interrupt the door stop.

10.9.3 Security Viewers

These items are suitable in the following applications only:

Leaf options: Flamebreak 660 Ply Faced and FF660 MDF faced.

Configurations: All configurations

Components with the following specification are also deemed acceptable.

- Door security viewers with brass or steel bodies of a diameter less than or equal to 15mm may be used provided that the through-hole is bored tight to the case of the viewer (maximum tolerance +1 mm). Lenses must be glass and the item must be protected with a tested acrylic intumescent mastic.
- Must be fitted no closer than 100mm to door edge, glazing or any other hardware component.

10.9.4 Door Selectors

These items are suitable in the following applications only:

Leaf options: Flamebreak 660 Ply Faced only

Configurations: All double leaf door configurations

These may be freely applied, provided that they are not invasive in the leaf edges or door frames, and they do not interfere with the self-closing action of the door leaf. Products that are invasive will require fire resistance test/assessment evidence to support their use which would need to be separately submitted to Warringtonfire or evaluation and inclusion in this report to permit their use with this door design.

10.9.5 Environmental Seals

A number of different environmental seals have been successfully tested as part of the Flamebreak 60 minute doorset designs. For example, the STS ST1009 weather seal was successfully tested in report WF408272.

On this basis, silicon based flame retardant acoustic, weather and dust seals (for example those referenced above or Lorient IS1212, IS1511, IS7025, IS7060 or Sealed Tight Solutions Ltd. ST1009) may be fitted to this doorset design without compromising the performance, providing their fitting does not interfere with the activation of the intumescent seals or hinder the self-closing function of the leaves.

10.9.6 Threshold Drop Seals

Threshold drop seals can be fitted to both the Flamebreak 660 Ply faced and FF660 MDF faced designs, only when an Exitex MXS/15-67 threshold plate is also installed as detailed in section 7.2. The full requirements of section 7.2 must be complied with, including the requirement for the ST202 gasket fitted to the upper surface of the plate.

The drop seal must be mounted into a full depth rail at the bottom of the door leaf (i.e. the bottom rail cannot be removed when installation of a drop seal is proposed).

Note: if a rebated drop seal is fitted to the doorset then flush bolts, if approved, may not also be fitted to the bottom of the doorset.

The following components are deemed acceptable, recessed into the bottom of leaves.

Product	Manufacturer
LAS8005si /0935A00	Lorient Polyproducts Ltd.
LAS8001si	Lorient Polyproducts Ltd.
RP8Si	Raven Products Ltd.
NOR810, NOR810S, NOR810dB+	Norsound Ltd.
STS 422	Sealed Tight Solutions Ltd

10.9.7 Air Transfer Grilles

10.9.7.1 Lorient Polyproducts Ltd Air Transfer Grilles

Lorient Polyproducts Ltd air transfer grilles are manufactured using modular elements, contained within the system is a sodium silicate based intumescent compound, which expands multi directionally in volume when exposed to elevated temperatures, forming a fire resistant seal.

10.9.7.1.1 Installation Requirements

Margins to the leaf edges will remain as detailed for glazing within section 6 and the position of the grille has been dictated by the pressure regime tested in the proving evidence (generally below mid-height). The area occupied by the air transfer grille must be deducted from the area of glazing if both elements are to be installed within a door leaf.

Part No.	Maximum Area (m ²)	Maximum Aperture Dimensions (h x w - mm)
LVN25	0.25	540 x 540
LVV40* & LVC40*	0.11	360 x 360

* Grilles may be fitted up to a maximum height of 2200mm from the threshold.

The Lorient Polyproducts Ltd air transfer grilles must be installed in accordance with the manufacturer's installation details, which include steel screws through either the perimeter frame of the grille or integral flanges and the grille must to be bedded onto an 8mm thick bead of Lorient Intumescent Sealant with a fillet of sealant on both faces at the junction between the liner and the air transfer grille - full details can be obtained from Lorient Polyproducts Ltd.. Grilles are manufactured using modular elements, finished grilles are available from 100 - 600mm in height and width; the maximum area for each grille type in the table takes precedence. Full details must be obtained from Lorient Polyproducts Ltd.

Optional cover grilles are available and may be used with no detrimental effect on the fire resistance of the grilles.

10.9.7.2 Pyroplex Air Transfer Grilles

The following Pyroplex air transfer grilles have been assessed as acceptable for use with the Flamebreak 60 design.

The grilles must be fitted a minimum of 100mm from the edge of the door leaf and a minimum of 80mm apart if more than one grille is to be fitted. The area occupied by the air transfer grille(s) must be deducted from the percentage of glazing and letter plate, if both elements are fitted. The grilles may be fitted up to a maximum height of 2200mm from the threshold.

Part No.	Dimensions (mm)	Air Flow (sq. cm)	Compatible Faceplates
ATG 1500	150 x 150	153	FP1500
ATG 1503	150 x 300	307	FP1503
ATG 1300	300 x 300	614	FP1300
ATG 2251	112 x 225	161	FP2251
ATG 2250	225 x 225	323	FP2250

The Pyroplex air transfer grilles must be installed in accordance with the manufacturer's installation details, which include a 6mm thick hardwood (excluding Beech (*Fagus sylvatica*)) aperture liner and Pyroplex intumescent mastic applied around the perimeter of the grille. Full details can be obtained from Pyroplex Ltd.

10.9.7.3 Mann McGowan Air Transfer Grilles

The table below details the tested and therefore approved air transfer grilles within the doorset design.

Configurations: All leaf configurations

Manufacturer & Product Reference (Test evidence)	Maximum Dimensions (mm)	Fixing Details	Intumescent Protection
Mann McGowan Pyrogrille 100 (WF391351)	598 w x 596 h	Fixings 75mm x 4.3mm drywall screws, nom 100mm from each corner applied through the vertical edges of the grille into the leaf.	Mann McGowan Pyromas A intumescent acrylic sealant. Cartridge gunned around the perimeter of each grille on both faces

In all instances the following specification must be followed:

- The aperture shall be lined with a hardwood (not Beech *fagus species*) minimum density 640kg/m³ aperture liner which is to be 6 - 8mm thick and adhered with PU or PVA adhesive and pinned with steel pins. The steel pins shall be positioned nominally 50mm from corners, no greater than 250mm centres and positioned centrally to the aperture liner.
- The air transfer grille must be fitted centrally to the leaf thickness.
- The size of any air transfer grille shall be no greater than 602mm high x 602mm wide or 0.36m².
- Air transfer grilles shall be rectilinear, other shapes are not permitted.

- Air transfer grilles shall be positioned such that the centre of the grille is 500mm \pm 200mm from the bottom of the leaf.
- Air transfer grilles shall not be closer than 200mm from the edge of the leaf or adjacent apertures within the leaf.
- It is possible to include a surface mounted ferrous or non-ferrous metal cover over the grille once installed providing it is applied with screws that are no longer than 20mm in length and when applied they are affixed into the leaf core material, i.e. not applied into the aperture liner or the grille itself.
- The area occupied by the air transfer grille must be deducted from the area of glazing if both elements are fitted.

10.9.8 Letter Boxes/Plates

Based on the proven capability of the Flamebreak 660 Ply Faced and FF660 MDF Faced door designs to tolerate apertures for glazing, components with the following specification are deemed acceptable.

- Pacific Rim Wood have requested specific reference to the Lorient Polyproducts RJ008 letterplate as detailed in CF5688, it is the opinion of Warringtonfire that these letter plates are acceptable for use subject to the following.
 - Letter boxes/plates must be Certifire approved products, for 60 minutes in doorsets with solid timber door leaves. Restrictions relating to size, location and intumescent protection around the letter box/plate detailed within the associated Certifire certificate must be complied with.
 - The area of the letter plate (and air transfer grille if present) plus any glazing must not exceed the total permitted area for glazing in the leaf.

10.9.9 Knockers, Numerals & Decals

These items are suitable in the following applications only:

Leaf options: Flamebreak 660 Ply Faced and FF660 MDF Faced

Configurations: All configurations

Components with the following specification are also deemed acceptable as in the opinion of Warringtonfire they will not significantly affect the fire resistance performance of the doorset being considered. This is on the basis of the items being surface mounted away from the edge of the door leaf, therefore unlikely to influence the junction between door leaf and frame. Furthermore, they are generally of lightweight construction, meaning that they are unlikely to destabilise the doorset and therefore cause adverse deflection under test conditions. Lastly, the surface mounted arrangement of the features means no material is removed in terms of the overall thickness of the door leaf beyond the footprint of the item, therefore burn through of the leaf would not be expected.

Approved specification:

- Steel, stainless steel, aluminium or bronze knockers, numerals or decals may be surface-fixed or bolted through the door leaf, providing they are fitted no closer than 75mm from the leaf edge or to any glazing and are no greater than 300mm high x 100mm wide. If through fixed, there must be no more than 1mm clearance between the hole and stud.

10.9.10 Surface Fixed Barrel Bolts

These items are suitable in the following applications only:

Leaf options: Flamebreak 660 Ply Faced only

Configurations: Double Leaf Configurations

It is permitted to fit a surface fixed barrel bolt to the top closing corner of a double leaf doorset providing the bolt does not require removal of material from the leaf or door frame and does not interfere with the perimeter intumescent seals. The bolt may be no longer than 450mm.

11 Installation

11.1 General

This section considers the installation of door frames and doorsets. This section considers:

- the door frame and architrave installation position relative to the wall
- the fire stopping between the frame and the wall and the use of shadow gaps.
- the fixing requirement including packers.
- the requirements for door edge gaps
- the trimming of door edges.

11.2 Door Frame Installation

The following figures indicate the acceptable door frame installations. Please note that the firestopping element is provided in the below 3D models as a generic red coloured seal. For further clarification of the approved firestopping systems see section 11.3.

Permitted Installations	
	<p>Instances where the door frame and the wall of the same depth such that architraves are fitted flush to both faces. Note that the minimum door frame section size (width and depth) must be as per the requirements noted in this report – see door frame section.</p> <p>Architraves requirements are documented in the firestopping section of this report.</p>
	<p>Instances where the wall thickness is greater than the door frame depth.</p> <p>In this scenario timber architraves of minimum 18mm thick must be fitted to both faces, fitted with a minimum 15mm overlap to the door gap, other than when the architrave abuts the wall.</p>
	<p>Split frames are permitted providing that both frame sections are secured to the wall in accordance with section 11.5. Furthermore, the main frame section (from which the door is hung) must be constructed to at least the minimum door frame section size (width and depth) as per the requirements noted in this report – see door frame section. The extension piece must be constructed using the same timber species as the main frame section.</p>

Note:

The drawings are provided as a generalised illustration of the door frame installation only; actual installation must be as per the text within this document specifies.

11.3 Firestopping

The firestopping requirements between the back of frame and wall are dependent on the gap size between the substrates. The table below provides the requirements based upon the gaps size. Please note that in the 3D depictions noted below show the application where a door frame is of the same depth as the overall wall thickness.

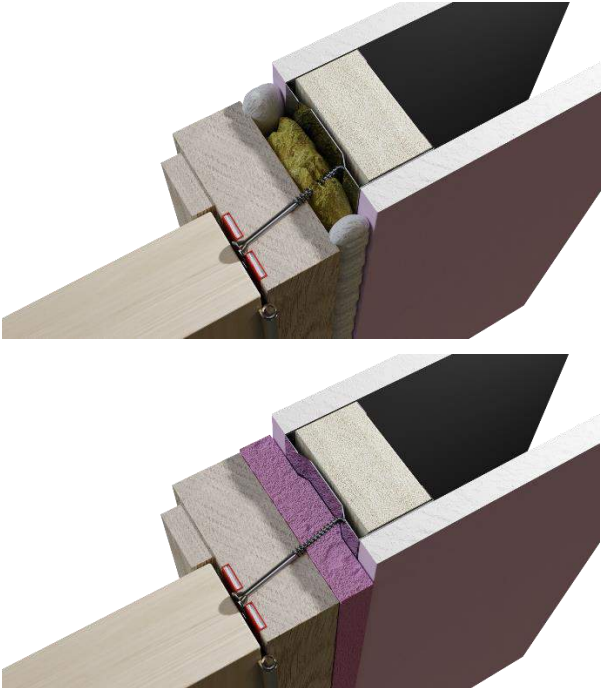
Gap (mm)	Requirement	3D model depiction
0 – 2	In practice, unlikely to occur, but if present, must be sealed with architraves, as below, fitted over a bead of acrylic intumescent sealant, tested as below.	N/A
3 – 10	Gap must be sealed on both sides with a 10mm depth of acrylic intumescent mastic, fire tested for this application to BS 476: Part 22: 1987 or BS EN 1634-1. Timber architraves of a minimum 18mm thick must be fitted to both faces, fitted with a minimum 15mm overlap to the door gap.	
10 – 20	Gap must be tightly packed with mineral fibre capped on both sides with a 10mm depth of acrylic intumescent mastic, fire tested for this application to BS 476: Part 22: 1987 or BS EN 1634-1 or full depth expanding PU foam, fire tested for this application to BS 476: Part 22: 1987 or BS EN 1634-1. Timber architraves of a minimum 18mm thick must be fitted to both faces, fitted with a minimum 15mm overlap to the door gap.	

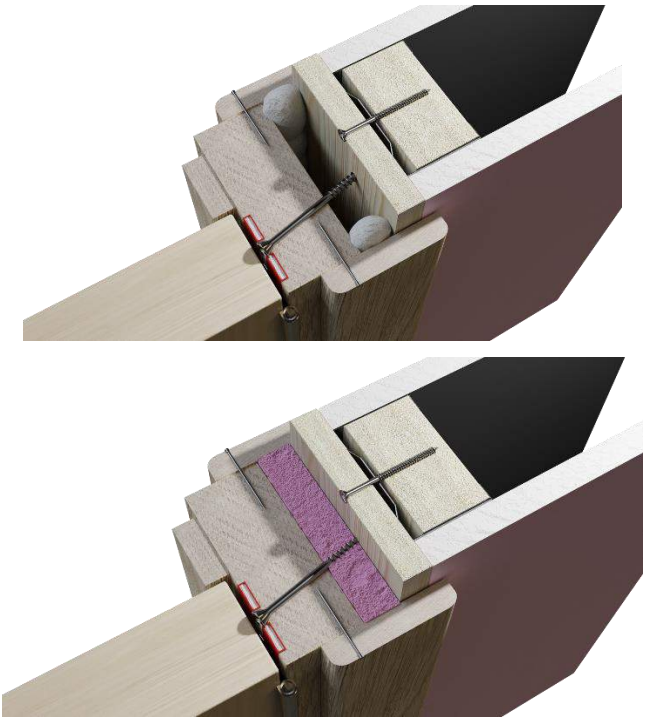
Gap (mm)	Requirement	3D model depiction
Over 20	<p>This would be considered a poor preparation of the structural opening. A timber based or non-combustible subframe up to 50mm thick can be inserted and fixed to the wall bedded on intumescent mastic, the gap between door frame and subframe filled as follows:</p> <p>Gaps 5 to 10mm filled on both sides with 10mm depth of acrylic intumescent mastic or full depth expanding PU foam, fire tested for this application to BS 476: Part 22: 1987 or BS EN 1634-1.</p> <p>Timber architraves of a minimum 18mm thick must be fitted to both faces, fitted with a minimum 15mm overlap to the door gap.</p>	

11.4 Packers

Packers can be timber of equal density to the frame, or plywood or plastic packers if fire tested for this application to BS 476: Part 22: 1987 or BS EN 1634-1.

11.5 Wall Types, Structural Opening & Fixity

11.5.1 Wall Types

The following wall types are approved for this doorset design:

- a) Plasterboard clad timber stud partitions
- b) Plasterboard clad steel stud partitions including timber lining.
- c) Masonry constructions

Wall types a & b above must have supporting fire resistance test evidence which demonstrates that it is capable of staying in place and intact for a minimum of 60 minutes whilst supporting a doorset design.

Wall type c above must be determined to be able to provide at least the same level of fire resistance as the doorset design.

All wall types detailed above shall provide a suitable medium to permit adequate fixity, it is anticipated that for:

- Plasterboard clad timber stud partitions, the timber stud will be of sufficient dimensions such that the fixing for the door frame penetrates into solid timber.
- Plasterboard clad steel stud partitions will include a timber lining of sufficient dimensions such that the fixing for the door frame penetrates into solid timber.
- Masonry constructions are anticipated to be constructed of a solid block or brickwork to receive the fixings.

Note: Other tested solutions to achieve adequate fixity may be detailed within the above noted supporting fire resistance test evidence.

11.5.2 Structural Opening

For all wall types the structural opening shall be square, plumb and provide a flat surface for installation of the doorset.

For flexible wall types such as steel and timber stud partitions the structural opening must be prepared in line with the test evidence provided by the wall manufacturer.

11.5.3 Fixings

The positioning of installation fixings in height should be planned to avoid conflicts with hardware, sealing systems and other building elements.

The fixings must be of the appropriate type for the supporting construction and must penetrate to a minimum depth of 40mm.

It is not necessary to fix the frame head, although packers must be inserted. However, for doorset widths in excess of 1100mm the use of an additional fixing centre width of the doorset at the head position is recommended.

See following diagram for illustration on fixings for a typical timber door frame doorset installation:

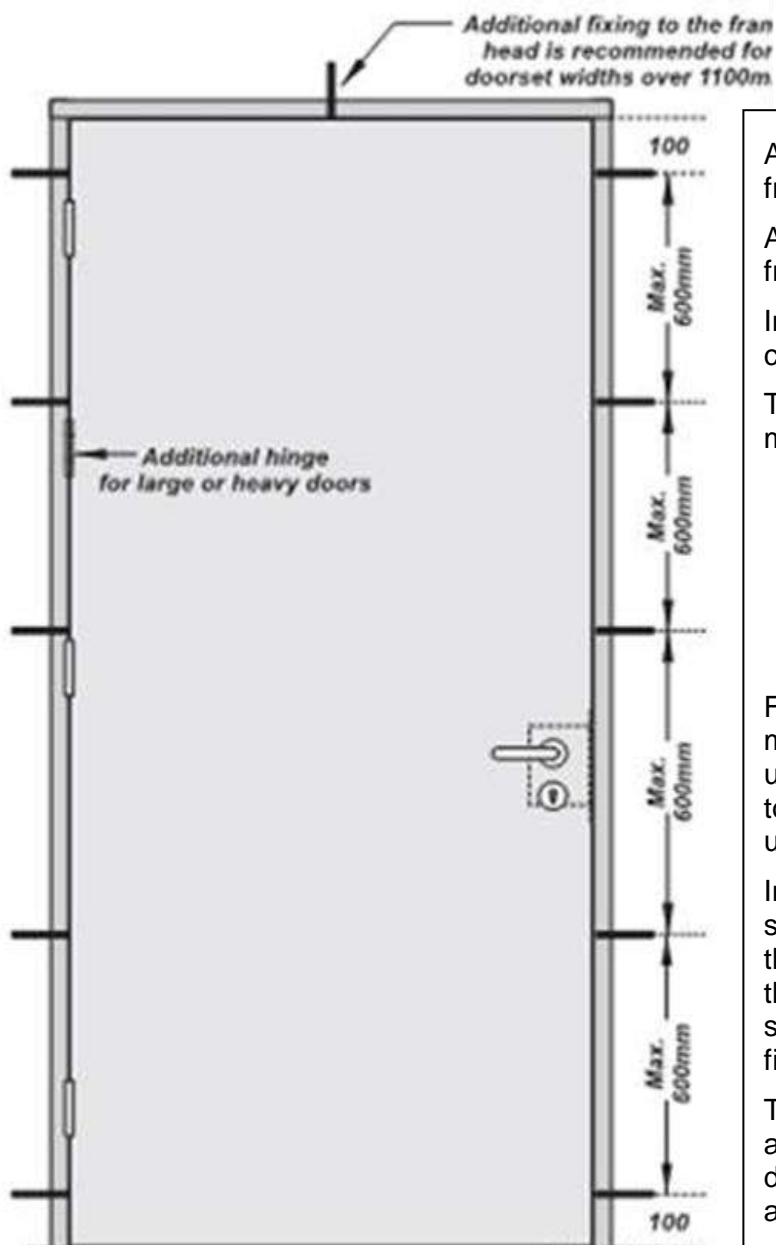

A top fixing must be located within 100mm from the underside of the leaf head.

A bottom fixing must be located 100mm from the bottom of the frame jamb.

Intermediate fixings must be located at centres of not more than 600mm.

The minimum number of fixings in height must be:

1. Doorset height up to 2000mm = 4No.
2. Doorset height 2000 – 2500mm = 5No.
3. Add 1No. fixing for each further 500mm increase in door height.

For storey height doorsets a top fixing must be provided within 100mm from the underside of the frame head with a further top fixing positioned 100mm from the underside of the transom rail.

In all instances the fixing position must be such that it provides adequate restraint to the element of construction throughout the exposure to fire. This may therefore sometimes necessitate a twin line of fixings.

The same fixing specification and arrangement is to be replicated for doorsets that are fitted within screen assemblies.

Timber frame fixing locations illustrated.

11.6 Postproduction (Onsite) Leaf Size Adjustment

Doorsets constructed using the Flamebreak 660 Ply faced and FF660 MDF faced door blanks may be altered as follows.

Leaf Size Adjustment Specification	
Element	Reduction
Lipping	The post-production lipping thickness may be reduced by 1mm for fitting purposes, providing that the door gaps and intumescent conditions remain as required by this assessment and the minimum limitation in terms of lipping thickness is still maintained

11.7 Door Gaps

Door gaps and alignment tolerances must fall within the following range:

Door Gap & Alignment Tolerance Specification	
Location	Dimension
Door edge gaps	A minimum of 2mm and a maximum of 4mm
Alignment tolerances	Leaves must not be proud of each other or from the door frame by more than 1mm.
Threshold	8mm between bottom of leaf and top of floor covering. This is the maximum tolerance for fire resistance only.

12 Insulation Performance

Insulation performance may be claimed for a doorset to this design meeting the following:

Insulation Performance Criteria	
Type	Details
Partially insulating	Doorsets incorporating up to 20% of non-insulating glazing or letter plates
Fully insulating	Unglazed doorsets or doorsets including 60-minute insulating glazing

13 Conclusion

If doorsets were to be constructed in accordance with the specification documented in this field of application and were to be tested in accordance with BS 476: Part 22: 1987, it is our opinion that they would provide a minimum of 60 minutes integrity and insulation (subject to section 12).

14 Declaration by the Applicant

- 1) We the undersigned confirm that we have read and comply with obligations placed on us by the Passive Fire Protection Forum (PFPF) Guide to undertaking technical assessments and engineering evaluations based on fire test evidence 2021 Industry Standard Procedure
- 2) We confirm that any changes to a component or element of structure which are the subject of this assessment have not to our knowledge been tested to the standard against which this assessment has been made.
- 3) We agree to withdraw this assessment from circulation should the component or element of structure, or any of its component parts be the subject of a failed fire resistance test to the standard against which this assessment is being made.
- 4) We understand that this assessment is based on test evidence and will be withdrawn should evidence become available that causes the conclusion to be questioned. In that case, we accept that new test evidence may be required.
- 5) We are not aware of any information that could affect the conclusions of this assessment. If we subsequently become aware of any such information, we agree to ask the assessing authority to withdraw the assessment.

(In accordance with the principles of FTSG Resolution No. 82: 2001)

Signed:

DocuSigned by:

1974A72C311946B

Name: Shaun Hannan

Position: Company Secretary

Date: 30-Apr-2024

For and on behalf of: **Pacific Rim Wood Ltd**

15 Limitations

The following limitations apply to this assessment:

- 1) This field of application addresses itself solely to the elements and subjects discussed and do not cover any other criteria or modifications. All other details not specifically referred to should remain as tested or assessed.
- 2) This field of application report is issued on the basis of test data and information to hand at the time of issue. If contradictory evidence becomes available to Warringtonfire, the assessment will be unconditionally withdrawn, and the applicant will be notified in writing. Similarly, the assessment evaluation is invalidated if the assessed construction is subsequently tested since actual test data is deemed to take precedence.
- 3) This field of application has been carried out in accordance with Fire Test Study Group Resolution No. 82: 2001.
- 4) Opinions and interpretation expressed herein are outside the scope of UKAS accreditation.
- 5) This field of application relates only to those aspects of design, materials and construction that influence the performance of the element(s) under fire resistance test conditions, against the ISO 834 time/temperature curve that is stipulated in the standard this assessment concludes to. It does not purport to be a complete specification ensuring fitness for purpose and long-term serviceability. It is the responsibility of the client to ensure that the element conforms to recognised good practice in all other respects and that, with the incorporation of the guidance given in this field of application, the element is suitable for its intended purpose.
- 6) This field of application report represents our opinion as to the performance likely to be demonstrated on a test in accordance with BS 476 Part 22: 1987, on the basis of the test evidence referred to in this report. We express no opinion as to whether that evidence, and/or this field of application would be regarded by any Building Control authorities or any other third parties as sufficient for that or any other purpose.
- 7) This report may only be reproduced in full. Extracts or abridgements of reports shall not be published without permission of Warringtonfire. All work and services carried out by Warringtonfire Testing and Certification Limited are subject to, and conducted in accordance with, the Standard Terms and Conditions of Warringtonfire Testing and Certification Limited, which are available at <https://www.element.com/terms/terms-and-conditions> or upon request.
- 8) The version/revision stated on the front of this Field of Application supersedes all previous versions/revisions and must be used to manufacture doorsets from the stated validity date on this front cover. Previous revisions of the Field of Application cannot be used once an updated Field of Application has been issued under a new revision.

16 Validity

- 1) The assessment is initially valid for five years after which time it is recommended to be submitted to Warringtonfire for re-appraisal.
- 2) This assessment report is not valid unless it incorporates the declaration given in Section 14 duly signed by the applicant.
- 3)

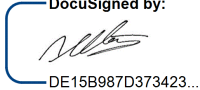
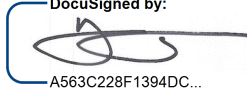
Position:	Assessor	Reviewer
Signature:		
Name:	* A M Winning	*P N Barker
Title:	Senior Product Assessor	Technical Governance Manager,

* For and on behalf of Warringtonfire

Appendix A: Summary of Supporting Test Evidence

This appendix lists every Pacific Rim Wood test Warringtonfire are aware of relating to the Flamebreak 66 and F660 designs. Not all the tests are specifically referenced in this FoA, they are included to demonstrate the breadth of testing undertaken which provides an additional level of comfort in the underlying performance of the designs, supporting assessments made within this document. Full details of the individual tests may be obtained from Pacific Rim if required.

Primary Data

Report No.	Configuration	Leaf Size (mm)	Test Standard	Performance (mins)
RF02054 (Palusol)	A: ULSASD	2070 x 935 x 54	BS 476: Part 22: 1987	A: 54*
	B: ULSASD	2062 x 935 x 54		B: 58*
RF02055 (Pyrostrip 500P)	ULSADD	2155 x 935/845 x 54	BS 476: Part 22: 1987	60
RF02117 (Pyrostrip 500P)	A: ULSASD	2080 x 937 x 54	BS 476: Part 22: 1987	A: 71
	B: ULSASD	2380 x 1179 x 54		B: 61
RF05042 (MDF facings)	A: ULSASD	2080 x 936 x 54	BS 476: Part 22: 1987	A: 63
RF08117 Rev A (PU lipping)	B: ULSASD	2040 x 826 x 54	BS 476: Part 22: 1987	B: 62
WF 307381 Issue 2	ULSADD	2156 x 936 x 54	BS 476: Part 22: 1987	62
WF374929	A: ULSASD	2200 x 26 x 54	BS 476: Part 22: 1987	60
WF503863	A: LSASD	2055 x 936 x 54	BS 476: Part 22: 1987	65
WF408272 AR1	LSASD	2040 x 928 x 54	BS 476: Part 22: 1987	Integrity: 71
				Insulation:71
RF05036	ULSASD	2133 x 1037 x 54	Integrity:	64
WF532372	2No. ULSASD	Both specimens: 2041 1028 54	BS 476: Part 22: 1987	A: 76 B: 65

* See test summary in appendix C for details of failure mode.

Supplementary Data

Report No.	Configuration	Leaf Size (mm)	Test Standard	Performance (mins)
WF 191350 (Pyrostem)	Fixed sample	1495 x 926 x 54	BS 476: Part 20: 1987	62
WF 313434 (Lorient glazing system RF1)	Indicative	1490 x 1490 x 54	BS 476: Part 20: 1987	74
IF11064 (Norsound NOR810S threshold seal)	Indicative	1032 x 926 x 54	BS 476: Part 20: 1987	64
IF12006 (Norsound Vision 60)	Indicative	1090 x 1090 x 54	BS 476: Part 20: 1987	64
IF12027 (Norsound Vision 60)	Indicative	1052 x 1020 x 54	BS 476: Parts 20/22: 1987	68
IF12051 (Norsound Vision 60)	Indicative	1300 x 1300 x 70	BS 476: Parts 20/22: 1987	79
IF12053 (Norsound Vision 60)	Indicative	1300 x 1300 x 70	BS 476: Parts 20/22: 1987	75
IF13077 (Norsound Universal 60)	Indicative	1054 x 1022 x 54	BS 476: Part 22: 1987	64
RF11151 (Norsound NOR910 & NOR920 hardware protection)	LSASD	2040 x 926 x 54	BS 476: Parts 20/22: 1987	56*
RF11143 (Pyroplex FG60 glazing system)	ULSADD	2054 x 928 x 54	BS EN 1634-1 & BS EN 1363-1	61
RF05036 (Pyrodur 60-10 glazed leaf in glazed screen)	ULSASD (Glazed single leaf in glazed screen)	Leaf 2133 x 1037 x 54 Screen 3000 x 3000	BS EN 1634-1 & BS EN 1363-1	64
RF12077 (Pyroclear 60-001)	3No. ULSASD	A & B: 2050x700x54 C: 2050 x 927 x 54	BS 476: Parts 20/22: 1987	A: 79 B: 72 C: 61
RF05035 (Pyrostop 60-101)	A: ULSASD	A: 2135 x 1040 x 54	BS EN 1634-1 & BS EN 1363-1	A: 66
RF05126 (Pyrobel 25)	A: ULSASD	A: 2135 x 915 x 54	BS EN 1634-1 & BS EN 1363-1	A: 59**
CF437 (Pyroguard 23mm thick glass)	Various	Various	BS 476: Part 22: 1987	60
CF5688 (Lorient Polyproducts Ltd RJ008 Letter plates)	Various	Various	BS 476: Part 22: 1987	60
WF68330/B (Lorient Air transfer grilles)	Fixed samples	Grille size: A: 300(w) x 300(h) C&D: 450(w) x 450(h)	BS 476: Part 20: 1987	A: 65 C: 85 D: 49
WF391351 (Mann McGowan Air transfer grilles)	B: LSASD	2040(h) x 926 (w) x 54(t)	BS EN 1634- 1:2014	69

* The failure witnessed at 56 minutes was due to a failure at the threshold of the leaf. No further failures were witnessed until 62 minutes. Therefore, Warringtonfire have assessed the intumescent hardware protection as suitable for inclusion as it had no bearing on the failure witnessed at 56 minutes.

** The failure witnessed at 59 minutes was attributable to the leaf to frame junction. No failure directly attributable to the glass was witnessed prior to termination of the test at 66 minutes.

Appendix B: Revisions

Revision	Warringtonfire Reference	Date	Description
A	A02141	05.03.03	Incorporation of additional test evidence Ref. RF02117 & RF02118 to include mixed hardwood stiles & rails and increase the leaf sizes in appendix D. Inclusion of MDF facings on LSASD. Filed under FEA/F03047.
B	A03047A	01.02.06	Change of top rail dimension to 100mm.
C	A07039	21.06.07	Update & revalidated for a further 5-year period.
D	A07171	22.08.07	Inclusion of Lorient Type 617 seals & revalidation for 5 years.
E	A09153	15.07.10	Update & revalidate assessment, including PU glue lines for lippings & Pyroplex seals for single leaf doors.
F	A09153	22.07.10	Edit to intumescent gaskets required for flush bolts & top pivots.
G	A11056	05.07.11	Technical review & update of assessment. Evidence from test WF 307381 has been included to permit 2No. 15 x 4mm Pyroplex seals for double doorsets. Assessment revalidated for a further 5-year period.
H	A13248	24.03.14	Inclusion of CS Ltd. Acrovyn & door edge protectors, Lorient RF1 glazing system, Pyroplex FG60 glazing system, Norsound Vision 60 & Universal 60 glazing systems, Norsound Vision fanlights & side screens, Norsound NOR 910/NOR 920 intumescent hardware protection, Norsound threshold seals, AGC Flat Glass UK Pyrobel 25, CGI Ltd. Pyroguard 60-23, Pilkington Group Ltd. Pyrostop 60-101 & Pyroclear 60-001, & Pilkington Pyrodur 60- 10 for fanlights & side screens.
I	CNA/F14089	22.04.14	Inclusion of updated Norsound Universal drawings, clarification on Norsound intumescent gasket thickness for protecting flush bolts, inclusion of additional Norsound threshold seals
J	WF396631	23.02.18	Technical reviewed, revalidated and update to new document format. Include clarification of lipping application, clarification of concealed closer application, Mann McGowan Palusol 100 removed, clarification of facing option restrictions for leaf sizes & configurations, false timber bead option removed & inclusion of Yeoman Shield/Lorient edge protectors based on Chilt/A08001 Rev C.

Revision	Warringtonfire Reference	Date	Description
K	WF 514531	09.02.22	<p>Report re-branded in the Warringtonfire name and styling. Scope of report based on the test evidence cited within Rev J but with the updates to scope linked to the results of the testing conducted by Pacific Rim Wood under WF 503863 and WF 503868. Assessment to have same expiry date as Rev J</p> <p>Specific scope updates to Flamebreak FF660 design:</p> <ul style="list-style-type: none"> • Coverage for Latched Single leaf Single Acting Designs only for MDF faced Flamebreak 60 • MDF leaves must have head rail and stiles present with max 5mm reduction to stiles and 3mm reduction to head rail permitted. • MDF design permitted with Mann McGowan perimeter seals only <p>Scope updates required for Flamebreak 660 and FF660:</p> <ul style="list-style-type: none"> • 10mm spaced perimeter intumescent seals for all configurations other than double leaf doorsets fitted on 3 No. hinges • Europrofile size locks in single leaf doorsets (MDF and ply faced), tubular mortice locksets in double leaf doorsets • Plywood faced design permitted as latched and unlatched single and double leaf configurations where full width head rail remains • Flush bolts and drop seals permitted when fitted into stiles/rails as appropriate and when fitted with intumescent protection • Doors clarified as requiring lipping on all edges (including the head) • Clarification on the use of Pyrodur glass in glazed screens based on RF05036 • Clarification on required glazing system for 23mm Pyroguard using CF437 • Clarification on required intumescent protection for cableway.
L	WF517091	09.02.23	<p>Addition of new test data (WF374929 & WF408272) to support the use of STS hardware protection & environmental seals.</p> <p>Addition of multipoint lock option.</p> <p>Removal of scope relating to letterplates, air transfer grilles, cableways and concealed closers.</p> <p>Removal of smoke control guidance section.</p> <p>Amendments to glazing section in line with Warringtonfire assessment rules</p>
M	WF534966	25.05.24	<p>Details of T-Shaped lippings added, STS leaf edge seal scope updated to only permit use with multi-point locks and 3No. seals in the head , re-introduction of letterplates and air transfer grilles, update to scope of edge protectors (CS and Yeoman Shield) re: maximum permitted leaf sizes and locksets</p>

Appendix C: Test Report Summaries

C.1 Fire Resistance Test RF02054

RF02054 is presented as primary data for the Flamebreak 660 Ply faced single leaf design when utilising Palusol intumescent seals.

Test Date	27 th May 2002	
Identification of test body	Chiltern International Fire, now trading as Warringtonfire testing and certification. UKAS notified body: 1762	
Test Sponsor	Pacific Rim Wood (UK) Ltd	
Summary of test constructions (mm)	2No Timber based Flamebreak 660 – unlatched single leaf, single acting configuration. Leaf Size (mm): Specimen A 2070 (h) x 935 (w) x 54 (t) Specimen B 2062 (h) x 935 (w) x 54 (t). Both specimens opening in towards the furnace.	
Test Standard	BS476 Part 22:1987	
Test Results	Specimen A	Specimen B
	Integrity: 54 minutes Insulation: 54 minutes	Integrity: 58 minutes Insulation: 58 minutes
Failure Mode	The failed single leaf, single acting doorset designs have been assessed through a change in the intumescent specification. The doorset were tested with 2 strips of 15 by 4mm and failed at the top closing corner. The intumescent specification has been increased to a single strip 30 by 4 mm in the head, which increases the intumescent from 52mm ² to 54mm ² (taking into account the PVC casing) but more importantly will give a better spread of intumescent at the centre portion of the door leaf. A 30 x 4mm head specification was successfully tested in RF02055 (see below), which further supports this assessment.	
Specimen Details (both specimens)	Specimen was mounted in hardwood door frame installed with 2No Lorient LP1504 leaf edge seals at the head and jambs with the rear of the frame protected with Rockwool and intumescent mastic. Specimen contained a TS83V overhead closer, 3No Royde & Tucker H101 lift off steel hinges, a tubular mortice latch and aluminium lever handles.	

C.2 Fire Resistance Test RF02055

RF02055 is presented as primary data for the Flamebreak 660 Ply faced single and double leaf designs when utilising Pyrostrip 500P intumescent seals.

Test Date	12 th June 2002
Identification of test body	Chiltern International Fire, now trading as Warringtonfire testing and certification. UKAS notified body: 1762
Test Sponsor	Pacific Rim Wood (UK) Ltd
Summary of test constructions (mm)	1No Timber based Flamebreak 660 – unlatched, double leaf, single acting configuration. Leaf Size: 2155 (h) x 935/845 (w) x 54 (t). Tested opening in towards the furnace.
Test Standard	BS476 Part 22:1987
Test Results In accordance with clause 7.6.1.1 of BS476 Part 22:1987, the glazing has not been evaluated for insulation	Integrity: 60 minutes Insulation: 60 minutes
Specimen Details	Specimen was mounted in hardwood door frame installed with 2No Mann McGowan Pyrostrip 500 15 x 4 leaf edge seals at the hanging jambs and one meeting edge only and 1No 30 x 4 seal in the leaf heads with the rear of the frame protected with Rockwool and intumescent mastic. Specimen contained a TS83V overhead closer on each leaf, 3No Royde & Tucker H101 lift off steel hinges, a tubular mortice latch and aluminium lever handles. Left leaf was glazed with 1 aperture using 6mm thick Georgian wired safety glass with an aperture size of 600 x 600, intumescent glazing system was the Sealmaster Ltd Fireglaze 60 with Palusol liner.

C.3 Fire Resistance Test RF02117

RF02177 is presented as primary data for the Flamebreak 660 Ply faced design in large single leaf designs when utilising Pyrostrip 500P intumescent seals.

Test Date	12 th November 2002	
Identification of test body	Chiltern International Fire, now trading as Warringtonfire testing and certification. UKAS notified body: 1762	
Test Sponsor	Pacific Rim Wood (UK) Ltd	
Summary of test constructions (mm)	2No Timber based Flamebreak 660 – unlatched single leaf, single acting configuration. Leaf Size (mm): Specimen A 2080 (h) x 937 (w) x 54 (t) Specimen B 2380 (h) x 1179 (w) x 54 (t). Both specimens opening in towards the furnace.	
Test Standard	BS476 Part 22:1987	
Test Results	Specimen A	Specimen B
	Integrity: 71 minutes Insulation: 71minutes	Integrity: 61 minutes Insulation: 61 minutes
Specimen Details (both specimens)	Specimen was mounted in hardwood door frame installed with 2No Mann McGowan Pyrostrip 500 15 x 4 leaf edge seals in the leaf head and jambs with the rear of the frame protected with Rockwool and intumescent mastic. Specimen contained a TS83V overhead closer, 3No Royde & Tucker H101 lift off steel hinges (4No on specimen B), a tubular mortice latch and aluminium lever handles.	

C.4 Fire Resistance Test RF05042

RF05042 is presented as primary data for the Flamebreak FF660 MDF faced single leaf design when utilising Pyrostrip 500P intumescent seals.

Test Date	16 th August 2005	
Identification of test body	Chiltern International Fire, now trading as Warringtonfire testing and certification. UKAS notified body: 1762	
Test Sponsor	Pacific Rim Wood (UK) Ltd	
Summary of test constructions (mm)	2No Timber based Flamebreak FF660 – unlatched single leaf, single acting configuration. Both Specimens: Leaf Size (mm): 2080 (h) x 936 (w) x 54 (t). Both specimens opening in towards the furnace.	
Test Standard	BS476 Part 22:1987	
Test Results	Specimen A	Specimen B*
	Integrity: 63 minutes Insulation: 63minutes	Integrity: 52 minutes* Insulation: 52 minutes
Failure Mode	Specimen B is not considered with this FoA report, the tested intumescent specification is not supported herein.	
Specimen Details	Specimen was mounted in hardwood door frame installed with 2No Mann McGowan Pyrostrip 500 15 x 4 seals in the frame head and jambs with the rear of the frame protected with Rockwool and intumescent mastic. Specimen contained a TS83V overhead closer, 3No Royde & Tucker H105 lift off steel hinges, an E*S tubular mortice latch and aluminium lever handles.	

C.5 Fire Resistance Test RF08117

RF08117 is presented as primary data for the Flamebreak FF660 MDF faced single leaf designs when utilising Pyroplex Ltd Rigid Box Seals intumescent seals and the use of PU adhesive for lipping glue-line.

Test Date	5 th September 2008	
Identification of test body	Chiltern International Fire, now trading as Warringtonfire testing and certification. UKAS notified body: 1762	
Test Sponsor	Pacific Rim Wood (UK) Ltd	
Summary of test constructions (mm)	2No Timber based Flamebreak FF660 – unlatched single leaf, single acting configuration. Leaf Size (mm): Specimen A 2040 (h) x 826 (w) x 54 (t) Specimen B 2040 (h) x 826 (w) x 54 (t). Both specimens opening in towards the furnace.	
Test Standard	BS476 Part 22:1987	
Test Results	Specimen A*	Specimen B
	Integrity: 54 minutes Insulation: 54minutes	Integrity: 62 minutes Insulation: 62 minutes
Failure Mode	Specimen A is not considered as supporting data herein, the tested, modified, leaf design is not supported.	
Specimen Details	Specimen was mounted in hardwood door frame installed with 2No Pyroplex Rigid Box Seals ref: 8700 15 x 4 seals in the frame head and jambs with the rear of the frame protected with Rockwool and intumescent mastic. Specimen contained a TS83 overhead closer, 3No Royde & Tucker H101 lift off steel hinges, a 'Euro Star' tubular mortice latch and aluminium lever handles.	

C.6 Fire Resistance Test WF307381 Issue 2

WF307381 is presented as primary data for the Flamebreak 660 Ply faced single and double leaf designs when utilising Pyroplex intumescent seals.

Test Date	28 th February 2011
Identification of test body	Exova Warringtonfire, now trading as Warringtonfire testing and certification. UKAS notified body: 0249
Test Sponsor	Pacific Rim Wood Ltd
Summary of test constructions (mm)	1No Timber based Flamebreak 660 – unlatched, double leaf, single acting configuration. Leaf Size: 2156 (h) x 936/936 (w) x 54 (t). Tested opening in towards the furnace.
Test Standard	BS476 Part 22:1987
Test Results	Integrity: 62 minutes Insulation: 62 minutes
Specimen Details	Specimen was mounted in hardwood door frame installed with 2No Pyroplex Rigid Box ref: 8700 15 x 4mm seals mounted 5mm apart in the frame head and jambs and one meeting edge only with the rear of the frame protected with Rockwool and intumescent mastic. Specimen contained a Briton 121 CE overhead closer on each leaf and 3No Royde & Tucker H102 steel hinges per leaf.

C.7 Fire Resistance Test WF374929

WF374929 is presented as primary data for the Flamebreak 660 Ply faced single leaf design supporting trimming options in section 5.2.1 and locksets in section 10.4.1.

Test Date	26 th October 2016	
Identification of test body	Exova Warringtonfire, now trading as Warringtonfire testing and certification. UKAS notified body: 1762	
Test Sponsor	Sealed Tight Solutions Ltd, Derwent House, Station Approach, Low Prudhoe, Northumberland, NE62 6NP	
Summary of test constructions (mm)	1No Timber based Flamebreak 660 – unlatched single leaf, single acting configuration. Leaf Size: 2200 (h) x 926 (w) x 54 (t). Tested opening in towards the furnace.	
Test Standard	BS476 Part 22:1987	
Test Results In accordance with clause 7.6.1.1 of BS476 Part 22:1987, the glazing has not been evaluated for insulation	Specimen A	Specimen B
	Integrity: 60 minutes Insulation: 60minutes	Specimen B is of a different leaf construction to the Flamebreak design assessed herein and is not considered further
Specimen Details	Specimen A was mounted in hardwood door frame installed with 2No Sealed Tight Solutions ST1504 15 x 4mm seals in the frame head and jambs with the rear of the frame protected with Rockwool and intumescent mastic to the exposed face only. Specimen contained an Arrone AR1500 overhead closer, 4No Zoo Hardware bearing butt steel hinges, an 'IR' mortice latch with a 235mm high forend and keep and steel lever handles.	

C.8 Fire Resistance Test WF503863

WF503863 is presented as primary data for the Flamebreak FF660 MDF faced single leaf design when utilising Pyrostrip 500P intumescent seals. This test specimen was sampled by BMTRADA during manufacture.

Test Date	3 rd August 2022
Identification of test body	Warringtonfire testing and certification. UKAS notified body: 1762
Test Sponsor	Pacific Rim Wood Ltd
Summary of test constructions (mm)	1No Timber based Flamebreak FF660 –latched, single leaf, single acting configuration. Leaf Size: 2055 (h) x 923 (w) x 54 (t). Tested opening in towards the furnace.
Test Standard	BS476 Part 22:1987
Test Results	Integrity: 65 minutes Insulation: 63minutes
Specimen Details	Specimen was mounted in hardwood door frame installed with 2No Mann McGowan 500P 15 x 4mm seals mounted 10mm apart in the frame head and jambs and one meeting edge only with the rear of the frame protected with Sealed Tight Solution ST88FR Acrylic mastic. Specimen contained a Dorma TS71 overhead closer, 3No Royde & Tucker H101 lift off steel hinges and a Zoo Hardware Vier 'DIN sashlock' with 235mm high forend and 180mm high keep with steel lever handles on a 51mm diameter steel escutcheon. The leaf was glazed with 16mm thick AGC Flat glass Pyrobel EI60/30, with ISL Therm-A-Line lining the aperture and ISL Therm-A-Bead between the glass and hardwood beads.

C.9 Fire Resistance Test WF408272

The tested specimen comprised a latched single acting leaf, tested opening towards the furnace. WF408272 is presented as primary data for the Flamebreak 660 Ply faced single leaf design when utilising ST154 intumescent seals and a multipoint lockset.

Test Date	20 th December 2018
Identification of test body	Warringtonfire. UKAS notified body: 1762
Test Sponsor	Pacific Rim Wood (UK) Ltd, Ground Floor Suite, Block B, Old Kelways, Somerton Road, Langport, Somerset, TA10 9SJ
Summary of test constructions (mm)	Timber based Flamebreak 660 – single leaf, single acting configuration. Leaf Size (mm): 2040 (h) x 928 (w) x 54 (t)
Test Standard	BS476 Part 22:1987
Test Results	Integrity: 71 minutes Insulation: 71 minutes (In accordance with clause 7.6.1.1 of BS476 Part 22:1987, the glazing has not been evaluated for insulation)
	Specimen was mounted in hardwood door frame installed with 2No STS ST154 leaf edge seals at the head and jambs of the door frame with the rear of the frame protected with Rockwool and intumescent mastic. 1No. single STS ST154 leaf edge seal was also centrally fitted in the head of the leaf. Specimen contained a TS3204 overhead closer, 3No HIN1433 Eurospec steel hinges, Winkhaus AV2 multipoint latch and an Exitex MXS/15-67 aluminium threshold. Leaf was glazed with 2 apertures using 12mm thick Promat Ltd Pyrobelite.

C.10 Fire Resistance Test RF05036

RF05036 comprised a glazed, single leaf doorset mounted in a glazed screen, and is presented as supporting test data for the use of glazed fanlights and sidescreens.

Test Date	21 st April 2005
Identification of test body	Chiltern International Fire, now trading as Warringtonfire testing and certification. UKAS notified body: 1762
Test Sponsor	Pilkington Glass Ltd, Pilkington Tech Centre, Hall Lane, Lathom, Ormskirk, L40 5UF
Summary of test constructions (mm)	Timber joinery, unlatched single leaf, single acting configuration mounted in a glazed screen. Leaf Size (mm): 2133 (h) x 1037 (w) x 54 (t), installed opening in towards the furnace.
Test Standard	EN1634-1:2000
Test Results	Integrity: 64 minutes, at top hinge of door leaf Insulation I ₂ : 20minutes
Specimen Details	Glazed screen comprised of 5No apertures, overall dimensions of 3000 (h) x 3000 (w) with one vertical edge unrestrained, constructed of hardwood framing. All glazed apertures, including within the door leaf, contained 10mm thick Pilkington Pyrodur 60-10 glass of various pane sizes. Within the screen elements the glazing system was the Sealmaster Ltd Fireglaze 60 with Palusol liner. Within the leaf the glazing system Hodgsons Firestrip 60 between beads and glass with Norseal flexible graphite liner as the aperture liner.

C.11 Fire Resistance Test WF532372

WF532372 is presented as primary data for the Flamebreak 660 Ply and FF660 single and double leaf designs when utilising T-shaped lippings.

Test Date	23 rd May 2023	
Identification of test body	Warringtonfire testing and certification. UKAS notified body: 1762	
Test Sponsor	Pacific Rim Wood Ltd	
Sampling Information	Sampled by a representative of QMARK under contract SC23116 Rev 2	
Summary of test constructions (mm)	2No Timber based Flamebreak FF 660 (MDF faced) – unlatched, single leaf, single acting configuration – door blank(s) certified under QMARK certificate 006/027. Leaf Size: 2041 (h) x 1028 (w) x 54 (t). Both tested opening in towards the furnace.	
Test Standard	BS476 Part 22:1987	
Test Results	Doorset A	Doorset B
	Integrity: 76 minutes Insulation: 76 minutes	Integrity: 65 minutes Insulation: 65 minutes
Specimen Details	<p>Both specimens were mounted in a hardwood door frame installed with 2No Lorient Type617 15 x 4mm seals mounted 10mm apart in the frame head and jambs in doorset A and 2No Pyroplex Rigid Box Seal ref: FO8700 15 x 4mm seals mounted 10mm apart in the frame head and jambs in doorset B.</p> <p>Both specimens include:</p> <p>Core of outer layers of falcatta lamels and an inner layer of mixed tropical hardwood lamels with 6mm thick MDF outer facings.</p> <p>Top rail from mixed tropical hardwood @ 610kg/m³, 75mm wide (total) x 42mm thick with 9mm x 9mm tongue into the core.</p> <p>Botom rail from mixed tropical hardwood @ 610kg/m³, 35mm wide (total) x 42mm thick with 9mm x 9mm tongue into the core.</p> <p>Stiles to both vertical edges from mixed tropical hardwood @ 610kg/m³, 35mm wide (total) x 42mm thick with 9mm x 9mm tongue into the core.</p> <p>Lippings – hardwood to all 4 edges @ 640kg/m³, 54mm wide x 10mm thick with 8mm thick x 25mm wide tongue into stiles and rails.</p>	

C.12 Fire Resistance Test Chilt/RF07141 Revision B

The left doorset was designated doorset A and the right doorset was designated doorset B. The left leaf of each doorset measured 2045mm high x 850mm wide x 54mm thick and the right leaf of each doorset measured 2045mm high x 323mm wide x 54mm thick.

Yeoman Shield/Lorient Polyproducts Ltd PVCu edge protectors were fitted to all vertical edges of specimens, comprised of a 2.0mm outer skin formed around 9.0mm toughened PVCu insert with legs extending 50mm across the leaf faces.

Both doorsets were orientated with leaves opening towards the furnace. It is therefore the opinion of Warringtonfire that the test results can be applied to doors opening in either direction. The left leaf of each doorset was fitted with a latch and face fixed bolts were fitted to the face of the half leaves, all disengaged for the duration of the test.

When tested in accordance with the principles of BS 476: Part 22: 1987, the specimens achieved the following performance:

Criteria	Doorset A	Doorset B
Integrity:	64 minutes	64 minutes
Insulation:	64 minutes	64 minutes

C.13 Fire Resistance Test Chilt/RF11061

The left doorset was designated doorset A and the right doorset was designated doorset B. The left leaf of each doorset measured 2100mm high x 900mm wide x 54mm thick and the right leaf of each doorset measured 2100mm high x 300mm wide x 54mm thick. Vertical leaf edges were protected with the CS Group Acrovyn. Both doorsets were orientated with leaves opening towards the furnace, considered to be the most onerous direction based on experience of testing similar door constructions. It is therefore the opinion of Warringtonfire that the test results can be applied to doors opening in either direction. Both doorsets were fitted with latches disengaged for the test.

When tested in accordance with the requirements of BS 476: Part 22: 1987, the specimens achieved the following performance:

Criteria	Doorset A	Doorset B
Integrity:	66 minutes	68 minutes
Insulation:	66 minutes	68 minutes

C.14 Fire Resistance Test Chilt/IF11010B

The left doorset was designated doorset A and the right doorset was designated doorset B. The leaves of each doorset measured 980mm high x 226mm wide x 54mm thick. Vertical leaf meeting edges were protected with 8mm thick profiled recycled PVC covered by 2mm thick CS Group Acrovyn extending 50mm across the leaf faces. Both doorsets were orientated with leaves simulated as opening towards the furnace, considered to be the most onerous direction based on experience of testing similar door constructions. It is therefore the opinion of Warringtonfire that the test results can be applied to doors opening in either direction. The left leaf of each doorset was fitted with a flush bolt, disengaged for the duration of the test.

When tested in accordance with the principles of BS 476: Part 22: 1987, the specimens achieved the following performance:

Criteria	Doorset A	Doorset B
Integrity:	64 minutes	64 minutes
Insulation:	64 minutes	64 minutes

C.15 Test Report IF12006

Date of Test:	31/01/2012
Identification of Test Body:	Chiltern International Fire, Chiltern House, Stocking Lane, Hughenden Valley, High Wycombe, Buckinghamshire, HP14 4ND. Laboratory UKAS No. 1762
Sponsor:	Norsound Ltd
Tested Product:	Section of Graduated Density Chipboard (GDC) door core including a single glazed aperture
Summary of Test Specimens:	<p>Overall Sample Size: 1090 mm wide by 1090 mm high x 54 mm thick</p> <p>Leaf Detail: Graduated Density Chipboard, Density 630kg/m³</p> <p>Mounting Detail: The door leaf section was fixed to the refractory lined restraint frame with 1No. 50mm long wood screw at each corner of the leaf.</p> <p>Glazing</p> <p>Aperture Size: 891 mm high x 886mm wide</p> <p>Sight Size: 855 mm high x 850 mm wide</p> <p>Expansion Allowance: 2-3 mm all around</p> <p>Bead Detail: Sapele, 18 mm high x 21 mm deep with a 6° chamfer and 2 mm rebate to accept glazing liner.</p> <p>Fixing Detail (Bead): Steel pins, 50 mm long, fitted 50 mm from corners, 150 mm centres at 30° to the face of the glass.</p> <p>Glass Type: Pilkington Pyroshield 2, 7 mm thick.</p> <p>Glazing Liner: Norsound Liner, 44 mm wide x 2 mm thick, applied lining the aperture.</p> <p>Glazing System: Norsound Vision 60 Slimline, 15 mm wide x 2 mm thick, fitted between the glass and the bead on both faces.</p>
Test Standard:	Test to the temperature and pressure conditions of BS 476-22: 1987.
Performance:	Integrity: 64 minutes

C.16 Test Report IF12027

Date of Test:	24/04/2012
Identification of Test Body:	Chiltern International Fire, Chiltern House, Stocking Lane, Hughenden Valley, High Wycombe, Buckinghamshire, HP14 4ND. Laboratory UKAS No. 1762
Sponsor:	Norsound Ltd
Tested Product:	Section of Graduated Density Chipboard (GDC) door core, hung within a Sapele frame, including a single glazed aperture. The door leaf was hung to open towards the heating conditions of the test.
Summary of Test Specimens:	<p>Overall Leaf Size: 1052 mm high x 1020 mm wide x 54 mm thick</p> <p>Frame Detail: Sapele, Density 640kg/m³, 70 mm deep x 32 mm wide, with a 12 mm deep x 12mm wide planted Sapele Stop</p> <p>Intumescent Detail: 2No. Pyroplex 8700 Rigid Box Seal's, 15 mm wide x 4 mm thick, fitted central to the frame reveal 10 mm apart.</p> <p>Weather Seal Detail: Norsound NOR710 10.2 mm x 11 mm, fitted to the upstand of the stop.</p> <p>Leaf Detail: Graduated Density Chipboard, 54 mm thick</p> <p>Lipping Detail: Oak, applied to the vertical edges, Density 640kg/m³</p> <p>Hardware:</p> <p>2No. 'EuroSpec', Stainless Steel Butt Type Hinges, 100 mm high x 32 mm wide (Blade Size) complete with 0.5mm thick Norsound hinge protection under each blade.</p> <p>Mounting Detail: The frame was fixed to the refractory lined restraint frame</p> <p>Glazing</p> <p>Glass Size: 814 mm high x 814 mm wide</p> <p>Sight Size: 768 mm high x 768 mm wide</p> <p>Expansion Allowance: 3 mm all around</p> <p>Bead Detail: Sapele, Density 640kg/m³, 20 mm wide x 26 mm high including a 15 mm wide x 1.5 mm deep rebate and a 15° chamfer.</p> <p>Fixing Detail (Bead): Steel pins, 50 mm long, fitted 50 mm from corners, 230-250 mm centres at 45° to the face of the glass.</p> <p>Glass Type: Pilkington Pyroshield 2, 7 mm thick.</p> <p>Glazing Liner: Norsound Ltd, Norsound Liner, 44 mm wide x 2 mm thick</p> <p>Glazing System: Norsound Ltd, Vision 60, 25 mm wide x 3 mm thick, fitted between the glass and the bead on both faces.</p>
Test Standard:	Test to the temperature and pressure conditions of BS 476-22: 1987.
Performance:	Integrity: 68 minutes

C.17 Test Report IF12051

Date of Test:	24/10/2012
Identification of Test Body:	Chiltern International Fire, Chiltern House, Stocking Lane, Hughenden Valley, High Wycombe, Buckinghamshire, HP14 4ND. Laboratory UKAS No. 1762
Sponsor:	Norsound Ltd
Tested Product:	Glazed screen formed from softwood framing utilising Norsound Norglaze 60 glazing system.
Summary of Test Specimens:	<p>Overall Sample Size: 1300 mm wide by 1300 mm high x 70 mm thick</p> <p>Frame Detail: Sapele, Complying to BS EN 942 Class J30, Density 640kg/m³, 32 mm wide x 70 mm deep.</p> <p>Mounting Detail: The frame was fixed within a plasterboard clad, timber stud supporting construction.</p> <p>Glazing</p> <p>Aperture Size: 1236 mm high x 1236mm wide</p> <p>Sight Size: 1184 mm high x 1184 mm wide</p> <p>Expansion Allowance: 3 mm all around, achieved by 3 mm thick hardwood setting blocks</p> <p>Bead Detail: Sapele, Density 640kg/m³, 26 mm high x 18.5 mm deep with a 20° chamfer and 1.5 mm rebate to accept the liner.</p> <p>Fixing Detail (Bead): Steel pins, Ø2 mm x 50 mm long, fitted 50 mm from corners, 150 mm centres.</p> <p>Glass Type: Pilkington Pyrodur EW60-10, 10 mm thick.</p> <p>Glazing Liner: Norsound Ltd, Norglaze 60 Liner, 42 mm wide x 2 mm thick, fitted lining the aperture.</p> <p>Glazing System: Norsound Ltd, Norglaze 60, 25 mm wide x 3 mm thick, fitted between the glass and the bead on both faces.</p>
Test Standard:	Test to the temperature and pressure conditions of BS 476-22: 1987.
Performance:	Integrity: 79 minutes

C.18 Test Report IF12053

Date of Test:	25/10/2012
Identification of Test Body:	Chiltern International Fire, Chiltern House, Stocking Lane, Hughenden Valley, High Wycombe, Buckinghamshire, HP14 4ND. Laboratory UKAS No. 1762
Sponsor:	Norsound Ltd
Tested Product:	Glazed screen formed Sapele framing utilising Norsound Vision 60 glazing system. 4No. glazed apertures, formed with shared transom and mullion arrangement
Summary of Test Specimens:	<p>Overall Sample Size: 1300 mm wide by 1300 mm high x 70 mm thick</p> <p>Frame Detail: Sapele, Complying to BS EN 942 Class J30, Density 640kg/m³, 32 mm wide x 70 mm deep.</p> <p>Mounting Detail: The frame was fixed within a plasterboard clad, timber stud supporting construction.</p> <p>Glazing</p> <p>Aperture A</p> <p>Aperture Size: 484 mm high x 383mm wide</p> <p>Sight Size: 434 mm high x 331 mm wide</p> <p>Aperture B</p> <p>Aperture Size: 484 mm high x 821mm wide</p> <p>Sight Size: 434 mm high x 769 mm wide</p> <p>Aperture C</p> <p>Aperture Size: 720 mm high x 383mm wide</p> <p>Sight Size: 668 mm high x 331 mm wide</p> <p>Aperture D</p> <p>Aperture Size: 720 mm high x 821mm wide</p> <p>Sight Size: 668 mm high x 769 mm wide</p> <p>Expansion Allowance: 3 mm all around, achieved by 3 mm thick hardwood setting blocks</p> <p>Bead Detail: Sapele, Density 640kg/m³, 26 mm high x 20 mm deep with a 20° chamfer and a 1.5 mm rebate to accept the liner.</p> <p>Fixing Detail (Bead): Steel pins, Ø2 mm x 50 mm long, fitted 50 mm from corners, 150 mm centres.</p> <p>Glass Type: Pilkington Pyrodur EW60-10, 10 mm thick.</p> <p>Glazing Liner: Norsound Ltd, Liner, 42 mm wide x 2 mm thick, applied lining the aperture.</p> <p>Glazing System: Norsound Ltd, Vision 60, 25 mm wide x 3 mm thick, fitted between the glass and the bead on both faces.</p>
Test Standard:	Test to the temperature and pressure conditions of BS 476-22: 1987.
Performance:	Integrity: 75 minutes

C.19 Test Report IF13077

Date of Test:	07/08/2013
Identification of Test Body:	Chiltern International Fire, Chiltern House, Stocking Lane, Hughenden Valley, High Wycombe, Buckinghamshire, HP14 4ND. Laboratory UKAS No. 1762
Sponsor:	Norsound Ltd
Tested Product:	Section of GDC door core, hung within a Sapele frame, including a single glazed aperture. The door leaf was hung to open towards the heating conditions of the test.
Summary of Test Specimens:	<p>Overall Leaf Size: 1022 mm wide by 1054 mm high</p> <p>Frame Detail: Sapele, Density 640kg/m³, 70 mm deep x 32 mm wide, with a 12 mm deep x 12 mm wide planted Sapele Stop</p> <p>Intumescent Detail: 2No. Pyroplex Rigid Box Seal, FO8700, 15 mm wide x 4 mm thick, fitted 10 mm apart, 7 mm from the exposed face.</p> <p>Leaf Detail: Graduated Density Chipboard, Density 630kg/m³±10%, 54 mm thick</p> <p>Lipping Detail: Sapele, applied to all edges, 6-8 mm thick, Density 640kg/m³</p> <p>Hardware:</p> <p>2No. Royde and Tucker H101 Lift Off Type Hinges, 100 mm high x 35 mm wide (Blade Size), complete with Norsound Hinge Gasket Nor 905, 0.5 mm thick.</p> <p>Mounting Detail: The frame was fixed to the refractory lined restraint frame</p> <p>Glazing</p> <p>Sight Size: 752 mm high x 720mm wide</p> <p>Glass Size: 742 mm high x 710 mm wide</p> <p>Expansion Allowance: 3 mm all around, with 3 mm hardwood setting blocks.</p> <p>Bead Detail: Hardwood, Density 640kg/m³, 21 mm wide x 14.5 mm high with a 1.5 mm high x 16 mm wide rebate to the inside edge.</p> <p>Bead Cladding: NORSOUND UNIVERSAL COVER PLATE, 1.2 mm thick</p> <p>Fixing Detail (Bead): Steel pins, 50 mm long x 2 mm thick, fitted 40 mm from corners, 150 mm centres.</p> <p>Fixing Detail (Bead Cladding): Steel Screws, 16 mm long.</p> <p>Glass Type: Schott Pyran S, 7 mm thick.</p> <p>Glazing Liner: Norsound Ltd, Universal LNR4202 Glazing Liner, 42 mm wide x 2 mm thick, applied lining the aperture.</p> <p>Glazing System: Norsound Ltd, Universal FD30B Glazing Strip, 15 mm wide x 3 mm thick, fitted between the glass and the bead on both faces.</p>
Test Standard:	Test to the temperature and pressure conditions of BS 476-22: 1987.
Performance:	Integrity: 64 minutes

C.20 Summary of Test Report WF68330/B

The referenced test report, the essential details of which are summarised below, is primary data for the use of Lorient air transfer grilles in timber door leaves.

Date of Test	24.09.1996	
Identification of Test Body	Warringtonfire Research, now trading as Warringtonfire Testing and Certification Ltd.	
Sponsor	Lorient Polyproducts Ltd, Endeavour House, Fairfax Road, Heathfield Ind. Est., Newton Abbot, Devon, TQ12 6UD	
Tested Product	3No. specimens of air transfer grilles mounted in timber door leaf sections.	
Summary of Test Specimen (mm)	<p>Specimen A – ‘Lorient LV40’; overall grille dimensions 300(w) x 300(h) x 40(t) mounted in a Blankfort 30 leaf 830(w) x 1075(h), grille bedded on Lorient intumescent mastic.</p> <p>Specimen C – ‘Lorient LV25’; overall grille dimensions 450(w) x 450(h) x 50(t) mounted in NT Shapland leaf 840(w) x 1075(h), grille bedded on Lorient intumescent mastic.</p> <p>Specimen D – ‘Lorient LV20’; overall grille dimensions 450(w) x 450(h) x 40(t) mounted in Blankfort 30 leaf 830(w) x 1075(h), grille bedded on Lorient intumescent mastic.</p>	
Test Standard:	General Principles of BS 476 Part20:1987	
Performance	Specimen	Integrity (mins)
	A	65
	C	85
	D	49

C.21 Fire Resistance Test Chilt/IF13095 Revision A

The leaves measured 1400mm high x 900mm and 300mm wide x 57mm thick. Top and bottom edges were lipped with 2.5mm thick Acrovyn and the leaves faced with 2.5mm thick Acrovyn. Vertical edges were protected with 2mm thick Acrovyn. The doorset was orientated opening towards the furnace, which is considered to be the most onerous direction based on experience of testing doors of similar construction. It is therefore the opinion of Warringtonfire that the test results can be applied to doors opening in either direction. The doorset was fitted with a latch disengaged for the test.

When tested utilizing the temperature and pressure conditions of BS 476: Part 20: 1987 and in accordance with the principles of BS 476: Part 22: 1987, the specimen achieved the following performance:

Criteria	Minutes
Integrity:	60 minutes
Insulation:	60 minutes

C.22 Certifire Certificate CF5688

The referenced CERTIFIRE certificate, the essential details of which are summarised below, is to be used to support the Lorient RJ008 letter plate for the proposed door leaf, as detailed in section 10.9.8 of this report.

Certifire certification is gained by a third party analysis of previously tested constructions and approval against quality procedures and represents a higher level of attestation than simple 'type' testing.

The Lorient RJ008 letter plate is approved on the basis of:

- a) Initial type testing
- b) A design appraisal against a Technical Schedule (TS32)
- c) Certification of quality management system to ISO 9001
- d) Inspection and surveillance of factory production control.

It is therefore deemed acceptable to use this approval as a basis for technical justification of the Lorient RJ008 letter plate, only, considered in this appraisal.

Validity period	Issued:	1 st November 2018
	Revised:	1 st November 2023
	Valid to:	31 st October 2028
Identification of certification body:	Warringtonfire testing and Certification Limited	
Sponsor:	Assa Abloy Limited T/A Lorient, Portobello School; Street, Willenhall, WV13 3PW	
Certified Product:	Lorient RJ007- TS008 Slimline Letterplate and Lorient RJ008 – TS008 Letterplate	
Technical Schedule:	TS32 – The contribution of letterplates and their associated accessories to fire resisting and smoke control doorsets with metallic or non-metallic leaves	
Summary of certification:	<p>The TS32 Certifire scheme aims to provide confidence that installed letter plates will be capable of contributing to the performance of the element (doorset) as a whole, without detriment to its fire resistance, for the designated fire resistance period and also to demonstrate compliance with fire performance specifications.</p> <p>NB: the basis and full scope of the approval is outlined in the referenced certificate</p>	
Test Standard:	BS 476: Part 22: 1987	

C.23 Fire Resistance Test 330936

330936 is presented as supporting data for the Record DFA127 face fixed closer used with Flamebreak FF660 MDF and Ply faced designs, doorset B was of a steel construction and is not considered herein.

Test Date	20 th November 2013
Identification of test body	Exova Warringtonfire, now trading as Warringtonfire testing and certification – UKAS 0249.
Test Sponsor	Record UK, Garrion Business Park, Smith Avenue, Wishaw, Strathclyde, ML2 0RY
Summary of test constructions (mm)	A: Latched, single acting, single leaf, comprised of a graduated density core with 6mm thick hardwood lippings. Oriented to open in, towards the heating conditions
Test Standard	BSEN1634-1:2008
Test Results	Integrity: 47 minutes Insulation: 47 minutes Failure occurred at mid height of the closing edge of the leaf, remote from the closer location, no further failures recorded prior to 62 minutes when the specimen was blanked off. The closer body fell off the exposed face at 35 minutes.
Specimen Details	Leaf Core: Graduated Density particleboard. Size (mm): 2040 (h) x 930 (w) x 54 (t). Frame: Hardwood of nominal density 650kg/m ³ , Head: 119mm wide x 55mm thick and jambs 94mm wide x 54mm thick, both with integral 20mm high stop. A Record DFA127 surface mounted automatic swing door operator was fixed to the exposed face, no additional intumescent materials were installed protecting the closer body or slide arm. The closer body was fixed to the frame head with the slide arm channel on the door leaf face.

C.24 Fire Resistance Test WF391351

WF391351 is presented as supporting data for the Man McGowan air transfer grilles used with Flamebreak FF660 MDF and Ply faced designs.

Date of Test:	09.DEC.2017
Identification of Test Body:	Exova Ltd. UKAS No. 0249 (Now trading under: Warringtonfire Testing and Certification)
Sponsor:	Mann McGowan Fabrications Ltd
Tested Product:	Doorset B: Latched, Single Acting, Single Leaf Doorset – LSASD, 2040(h) x 926 (w) x 54(t) graduated density chipboard core.
Tested Orientation:	Doorset B: Opening towards the furnace
Sampling information:	No sampling report included
Test Standard:	BS EN 1634-1:2014
Performance:	<p>Integrity: Doorset B: Sustained flaming: 69 minutes Cotton pad test: 69 minutes Gap gauge: 69 minutes</p> <p>Insulation I₂: Doorset B: 69 minutes</p>
Reason for Use	For use as primary evidence for <ul style="list-style-type: none"> • Hardware • Air transfer grille